

ICES CM 2012/O:11 –How does renewable energy production affect aquatic life

Small scale distribution of fish in offshore wind farms

Kamilla Sande Hansen, Claus Stenberg and Peter Rask Møller.

Abstract

A stationary camera system was used to study the small scale distribution of fish in the two offshore wind farms (OWF) Middelgrund and Lillgrund in Øresund Strait, between Denmark and Sweden. Fish distribution was examined at approximately 0, 25 and 50 m from the turbines. The study found that the fish fauna near the wind turbines was dominated by two-spotted gobies, *Gobiusculus flavescens* (Fabricius, 1779). There was a significant difference in numbers of fish for Lillgrund and Middelgrund OWF. At Lillgrund sediment was dominated of bare sand while Middelgrund had more heterogeneous sediment types with sand, boulder, pebbles and dense eelgrass areas. This suggests that OWF in areas with homogeneous sand sediment has a higher impact on the fish fauna compared to OWF in areas with heterogonous sediment. Furthermore, the effect of OWF on fish appears to be on a much smaller scale than previously thought.

Keywords: Offshore wind farm, Øresund, distribution, fish.

Contact author: Kamilla Sande Hansen. Tel: +47 98 48 87 79. E-mail: kamillash@yahoo

Introduction

Offshore wind farms (OWF) is increasing in the world, with Europe as a leading continent (Azau & Casey, 2011). OWF's have until know been placed in relatively shallow waters (< 20 m) and on sandy seafloor habitats due to engineering constrains and to minimize establishment cost. Establishment of an OWF introduces a new habitat type with turbine construction and erosion protections by boulders to the sandy habitat (Petersen & Malm, 2006). Introduced hard substrate by boulders, turbine foundation on seabed and the vertical part of the turbine that cuts through water column has the potential to effect the marine environment. Hard substrate provides a new habitat for species associated to this habitat type and a subsequent habitat loss for species associated to sand habitat. Perkol-Finkel & Benayahi (2006) showed that organisms colonizing a new reef are adding, and not detracting, species from surrounding reefs and areas. Added hard

substrate can be viewed as an artificial reef (e.g. Wilhelmsson *et al.*, 2006a). Wilhelmsson *et al.* (2006a) showed that species such as blue mussels and red algae occurred in higher density around the turbine than elsewhere in the OWF-area.

Studies in in OWFs on fish have mainly been done by gillnets, trawls (Klaustrup, 2006, Leonhard *et al.*, 2011), sledge (van Deurs, *accepted*), hydro acoustic methods (Leonhard *et al.*, 2011; Couperus *et al.*, 2010) or divers (Öhman & Wilhelmsson, 2005; Andersson & Öhman, 2010). None of these studies have shown any overall negative effects on fish abundance or diversity in an OWF. Several studies indicate that fish aggregates around turbines at a small scale (e.g. Santos *et al.* 1996; Wilhelmsson *et al.*, 2006a). However, the methods used have not allowed a high spatial resolution or been able to obtain data from very close to the turbines or boulder protection. Therefore, knowledge about small scale distribution of fish around turbines in offshore wind farms has remained relatively scarce.

A method using underwater video (StatCam) to qualify and quantify fish distribution and utilization with high spatial resolution around wind turbines was therefore developed. Advantage with these methods compared to sonar scans is the absence of a boat which potentially can scare fish while in the wind farm area. The method with underwater video have been used with success monitoring coral reef fish (Dearden *et al.*, 2010), but to our knowledge it has not been used before for monitoring in OWFs.

StatCam give pictures of spatial fish distribution in an OWF and information on how the fish is distributed during the day. These distributions patterns vary dependent on the habitat present in the different OWFs. As for Lillgrund the OWF gave an introduction of boulders in an area mostly consisting of sandy seabed. While for Middelgrund boulders were already present and the introduction of the boulder around the turbine is not believed to have the same impact on the habitat changes.

Increased knowledge in small scale distribution and how the fish uses the turbine as a shelter can be used for the purpose of co-use or multi functions of an OWF and to understand if the farm can function as a marine protected area (MPA) or to get a deeper insight in the species composition in an OWF.

The aim to present in this project was to analyze the small scale distribution of fish in an OWF. It is hypothesized that the fish uses the turbines as an aggregation point in lack of shelter or preferable substrate in the area and that the OWF will increase the fish abundance. It is also

believed that the fish will use the turbine as a shelter or protection from the currents to save energy. Another theory is that fish uses the turbine to easy access to food by feeding on the growth on the turbine itself or by feeding vertical in water column. Regarding variation during day it is hypothesized that occurrence of small fish will dominate during day while larger fish and predators are expected to enter the farm when sun sets.

Material and method

Quantification of fish abundance around turbines in Lillgrund and Middelgrund OWF was carried out under several campaigns in August to November 2011 (Figure 9 and Table 1). Quantification was done by underwater video used two different setups. At first stationary cameras (StatCam) were placed along a transect at increasing distances from a turbine for several days. In the second setup turbine cameras (TurbCam) were deployed for a few hours at four sites around the turbine in order to cover both areas exposed and in shelter from current.

StatCam filmed in a transect from wind turbine number A05 at Lillgrund with coordinates: N55.5063 E12.7897 decimal degrees. TurbCam at turbine number B08 with coordinates N55.4995 E12.7734 decimal degrees. At Middelgrund StatCam were placed at turbine number 10, coordinates: N55.6923 E12.6707 decimal degrees. And turbine cameras at turbine number 4 and 5 with coordinates N55.7004 E23.6698 and N55.7022 E12.6697 decimal degrees. StatCam #1 was placed 0 m from the turbine, StatCam #2 placed 25 m from turbine and StatCam #3 was placed 50 m from turbine. Turbine camera was placed 0.70 to 1 m from turbine.

Table 1: Overview of the data-collecting activities at Lillgrund and Middelgrund OWF.

Location	Date	StatCam (number)	TurbCam (number)	Sediment mapping	Gill net	Fyke net	Snorkeler
Middelgrund	1/8-11	1 – 3	-	-	-	-	-
	2/8-11	1 – 3	-	-	X	-	-
	3/8-11	1 – 2	-	-	X	-	-
	19/9-11	1 – 3	-	-	-	-	X
	20/9-11	1 – 2	-	-	X	-	-
	21/9-11	1 & 3	-	X	X	X	-
	22/9-11	1 & 3	-	-	-	-	-
	23/9-11	1 – 3	-	-	X	X	X
	22/11-11	-	1 – 4	-	-	-	-
	24/11-11	-	1 – 3	-	-	-	-
Lillgrund	14/10-11	1 – 3	-	X	-	-	-
	15/10-11	1	-	-	-	-	-
	23/11-11	-	1 – 3	-	-	-	-

Camera setup

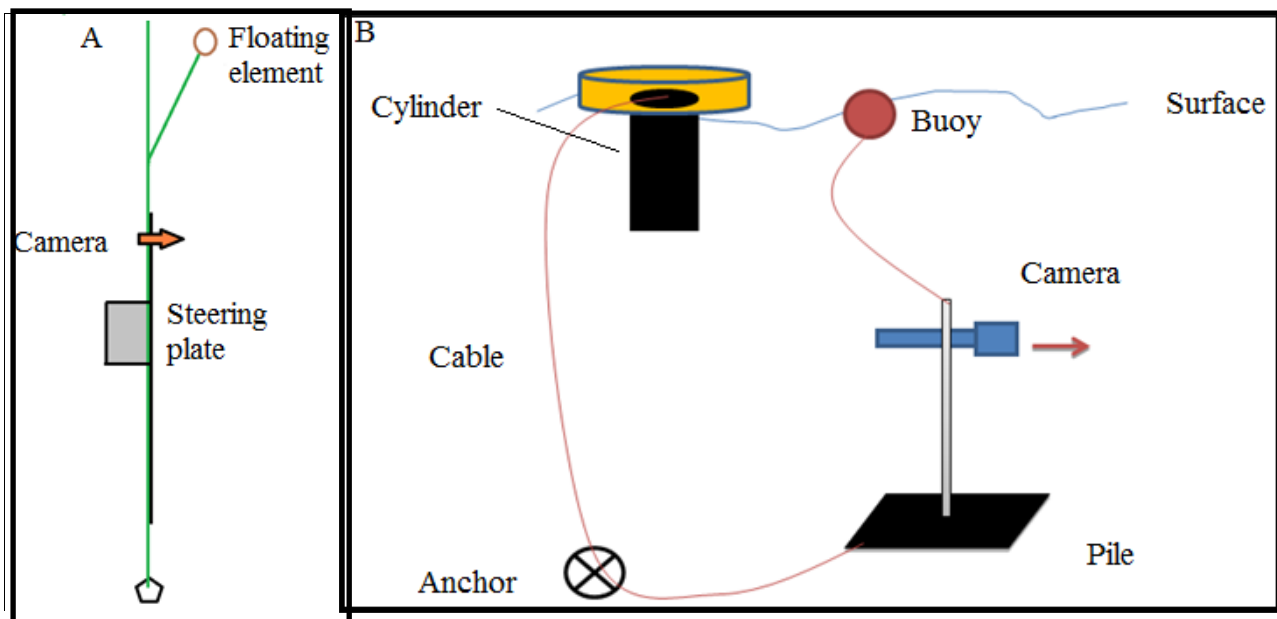

Figure 1A: Installation of Turbine Camera. Arrow indicates camera. The square represents a steering plate to keep the camera stable.

Figure 1B: Installation of StatCam with camera installed on pile on seabed. Cylinder in surface containing battery and recorder.

StatCam

StatCam were placed at increasing distance of approximately 0, 25 and 50 m from the turbines. The three cameras filmed simultaneously. Thereby preventing re-counting of the same fish if they swam along the transect. A schematic drawing of the StatCam setup is seen in Figure 1. Gill nets and fyke nets catches from the same period in Middelgrund OWF and were used to validate identifications of species encountered on the video (see my report Hansen, 2012).

The camera, a Diver Pro QX from LH-camera (<http://www.lh-camera.dk>), records in HQ (780 × 480 p) and uses 90 mAh/hour (Ampere hours). The video signal was transferred by cable to a surface buoy to a MPEG4 recorder that stored the video on a 32 GH micro SD card. Three batteries with a total of 36 Ah supplied the camera and recorder with power. Batteries had a capacity around 100 hours when fully charged. The micro SD card could hold approximately 10 hours of video. Camera could only record in daylight conditions. Good light conditions were normally observed to be present 1 hour before sunrise/after sunset.

Number of fish, size, placement in water column and species were registered while analyzing the recorded data. Registrations were done by stopping the film every second minute over a period of ten minutes per hour. Analyzed amount is considered representative for the whole hour.

TurbCam

Cameras mounted on a metal stands 1.5 m above sea bed (Figure 1A) were placed as close as possible to the turbine. Cameras were a ATC 9K from Oregon Scientific. Video was recording in HD (1280 x 720, 60 frames/sec). This setup gave video recordings from 3.5 to 5.5 m depth in both OWFs. Three to four cameras in total were placed by the turbine each day, two up towards the current (called CU) and two in shelter (called SH). The metal stands were equipped with plates to create stabilization for the camera (Figure 1A). Current data (from the same periods as the TurbCam was deployed) was obtained from 4 m depth at Drogden light house (coordinates 55°32'133"N 12°42'707"E) monitored by the Danish Maritime Safety Administration (<http://ifm.frv.dk>). Drogden is positioned 17 km south of Middelgrund and 8 km southwest of Lillgrund, and was assumed to be representative for both OWFs.

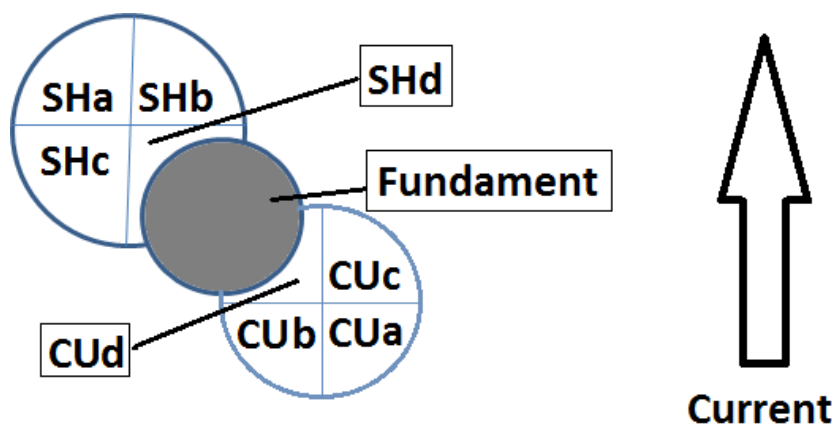

Figure 2: Dividing the potential zones for recording around the turbines. CU is *Current* and is on the side of the turbine where the current comes from. SH stands for *Shelter* and is on the current-shelter side of the turbine. Arrow indicates current direction. Zone a, b and c is the areas without turbine in immediate vicinity whilst zone d is close to the turbine. Zone a, b and c were registered as one as the target is to see if the fish uses zone d actively.

Habitat classification

Seabed was surveyed with a video sledge in order to map the sediments and benthic/sessile organisms/flora/macro algae creating the habitat for fish in the area. The camera mounted on the sledge was a ATC 9K from Oregon Scientific (same specification as mentioned above). Habitat

type classifications were made in October at Lillgrund and September at Middelgrund (Table 1). Information about the seabed provides information of the surrounding areas of the turbine.

Video transects was made by a video sledge towed at low speed (< 1 knots) behind the boat. Position of boat was recorded on a GPS and stored in a file. The video and positioned files were merged in the software packages *Video Navigator* from Institute of Marine Research. Habitat types along transects were classified according to sediment type and associated sessile flora and fauna. The following substrate categories were used; “pure sand”, “pebbles”, “sand with < 10 % pebbles coverage”, “sand with < 15 % pebbles coverage” and “boulder”. Sessile benthic flora and fauna were categories into “*Mytilus*” (*Mytilus edulis*, blue mussels); “*Zostera*” (*Zostera marina*, eelgrass) and “macro algae” (dominated by red algae).

Statistical analyzes

Number of fish per video sequence followed a negative binomial distribution. Data were therefore analyzed in a negative binomial distribution model (by the SAS Genmod procedure) for the effects of distance to turbine foundation (0, 25 or 50 m) and time of day (morning (sunrise + 3 h), day (between morning and evening) and evening (sunset – 3 h)). The analysis was planned to be carried out on the groups “two spotted gobies”, “other species” and “not identified to species”.

Results

Habitat classification

To give indication on the substrate in the area where the camera were set transect closest to the cameras are the one analyzed. The habitat types at Lillgrund and Middelgrund was very different. At Lillgrund the area from 0 to 5 m from the turbine was dominated by boulders which formed a reef structure. Outside this area the seafloor was a monotype pure sand habitat (Figure 3A). The boulders were mainly covered by *Mytilus* with abundance peaks where boulders were registered. From 30 to 42 m from the turbine *Zostera* started to dominate (Figure 3B). Macro algae was especially observed within the first 10 m of the transect but had low coverage (< 10%). The macro algae were dominated by red algae.

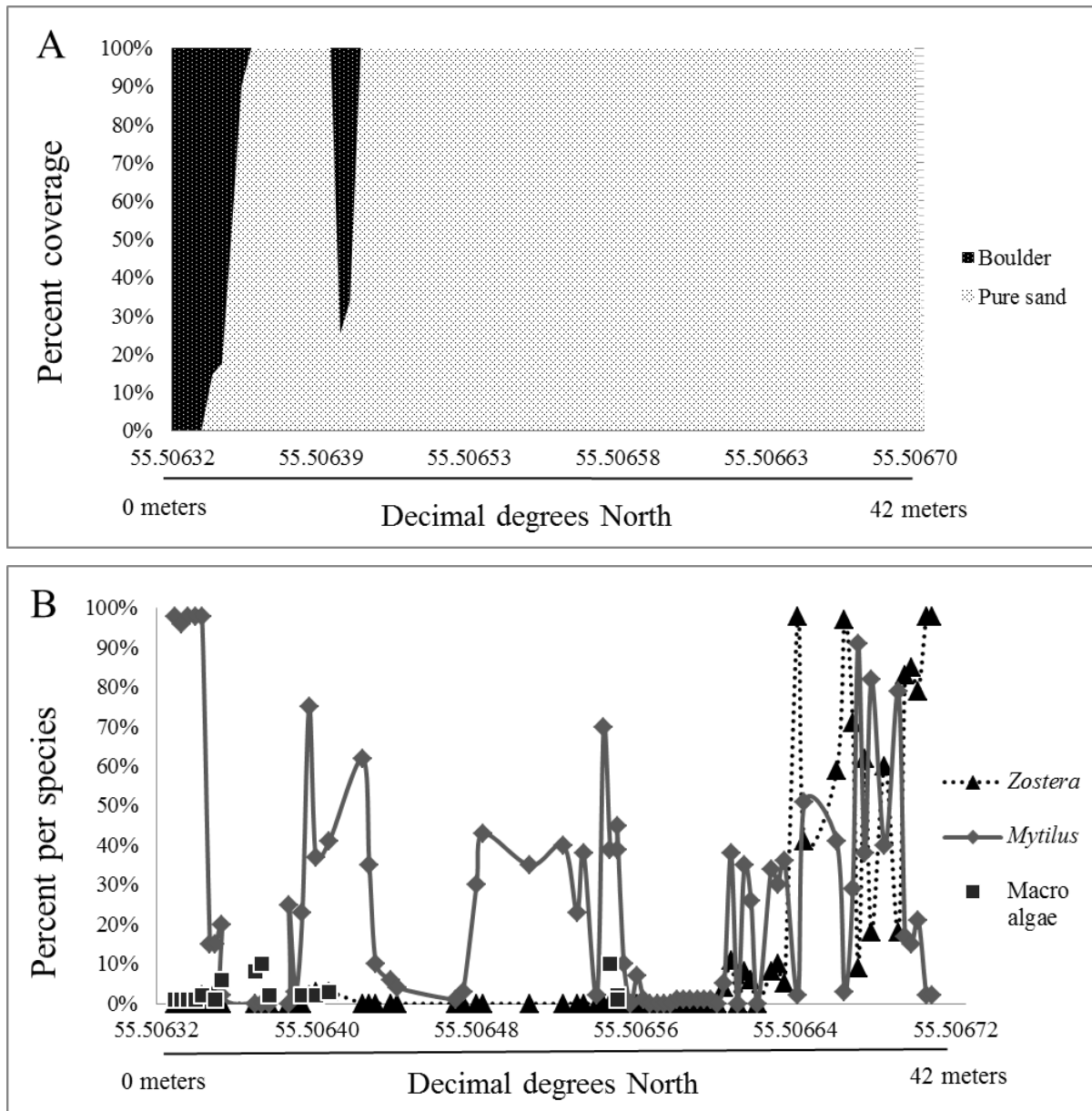

Figure 3A: Seabed substrate in transect at Lillgrund. Numbers in percent coverage and decimal degrees North. Boulder from 0 m is boulder around turbine.

Figure 3B: Seabed species in transect at Lillgrund. Numbers in percent coverage at decimal degrees North. Transect is 42 m long. *Zostera* is eelgrass and *Mytilus* is blue mussels. Macro algae was dominated of red algae.

At Middelgrund no boulders were visible at area close to the turbine. Instead the seafloor was dominated by sand with < 10 % pebbles (Figure 4A). Where pebbles dominate the seabed covering is dominated by *Mytilus* and macro algae (mainly red algae).

Additional transects was analyzed at Middelgrund as the transects reported above could be argued not to be representative for the area as we had to place StatCams outside dense *Zostera*

areas. These transect showed that the seabed has a high diversity of substrate and species. A category of sand with < 15 % pebbles covering were made as the pebbles amount were higher in those areas (Appendix Figure 10 and Figure 11).

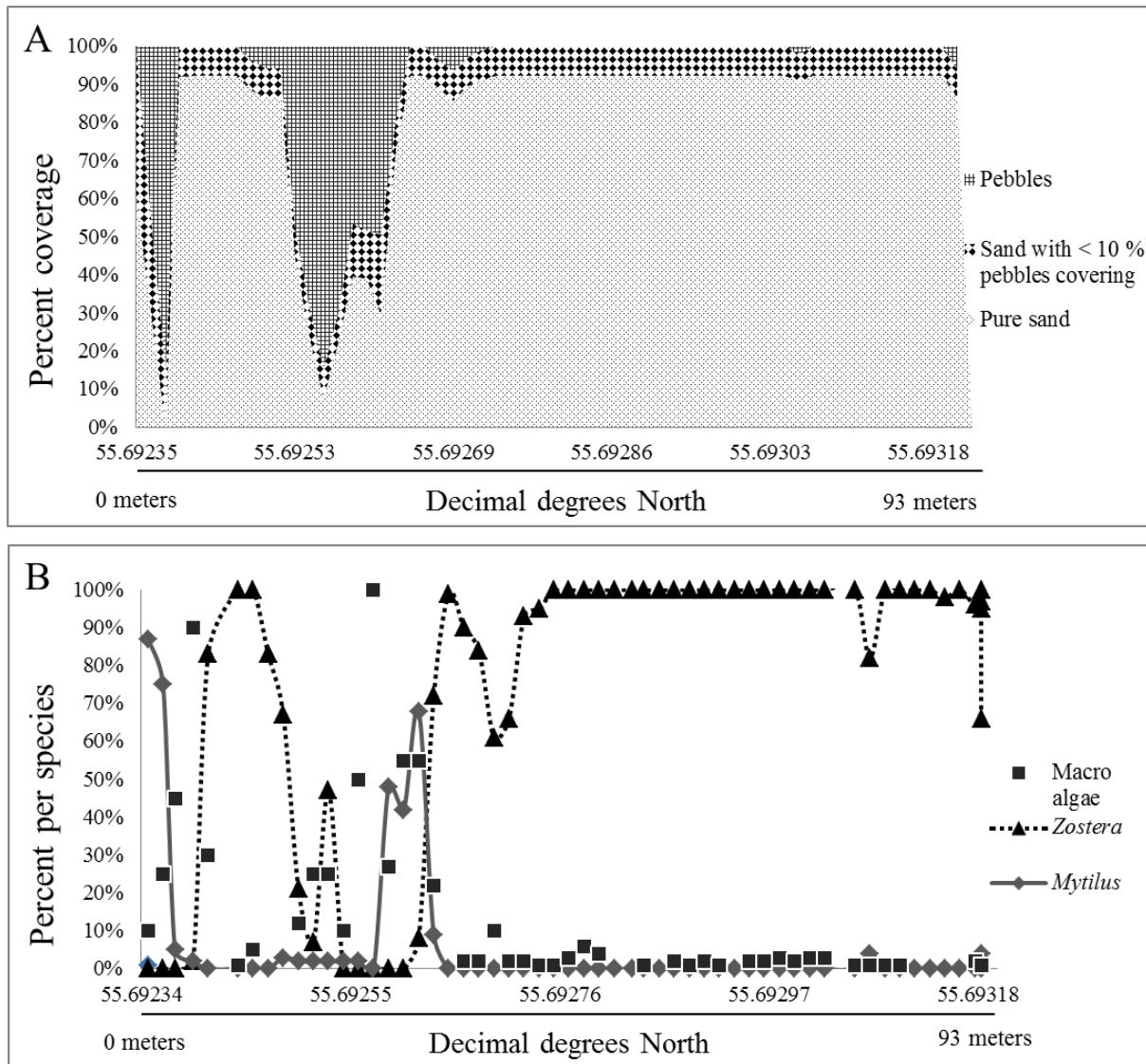

Figure 4A: Sea bed substrate in transect at Middelgrund. Numbers in percent coverage and decimal degrees North.

Figure 4B: Sea bed species in transect at Middelgrund. Numbers in percent coverage at decimal degrees North. The transect was 93 m long and started approximately 6 m west of turbine. Macro algae was dominated of red algae.

Spatial distribution of fish

At Lillgrund the observations were almost totally dominated only two spotted gobies.

Furthermore, two spotted gobies (*G. flavescens*) were only observed at the camera at 0 m and not

at all at cameras at 25 or 50 m. To analysis the effects of distance and time of day the analysis was consequently only carried out for total number of fish observed. The analysis showed that distance to turbine has a highly significant effect in the model with significant more fish at “0 m” compared to “25” and “50 m” ($p < .0001$) with no difference between “25” and “50 m” ($p > 0.47$). At “0 m” the observed abundance was observed to be almost 100 fold higher compared to 25 and 50 m distance. Time of day also had a significant effect in the model ($p < .0001$). Highest number of fish was observed at “day” were almost twice as many fish were observed compared to “morning” and “evening”. For Camera #1 at 0 m a mean of 632 fish were observed per recorded hour. All fish observed was in the size range 1 to 10 cm.

The observed species was dominated by two-spotted goby (*G. flavescens*) which constituted 92.6 % of the total observed fish with StatCam at Lillgrund. With its large dark spot placed at the peduncle, often saddles on the back two-spotted gobies are usually easy to recognize (Bracken & Kennedy, 1967). No other species observed could be identified to species level at Lillgrund, but size, color and placement in water column gives indications of species. The unidentified benthic and benthopelagic is most likely sand goby. Fish categorized as pelagic is believed to be gobies (Figure 5B).

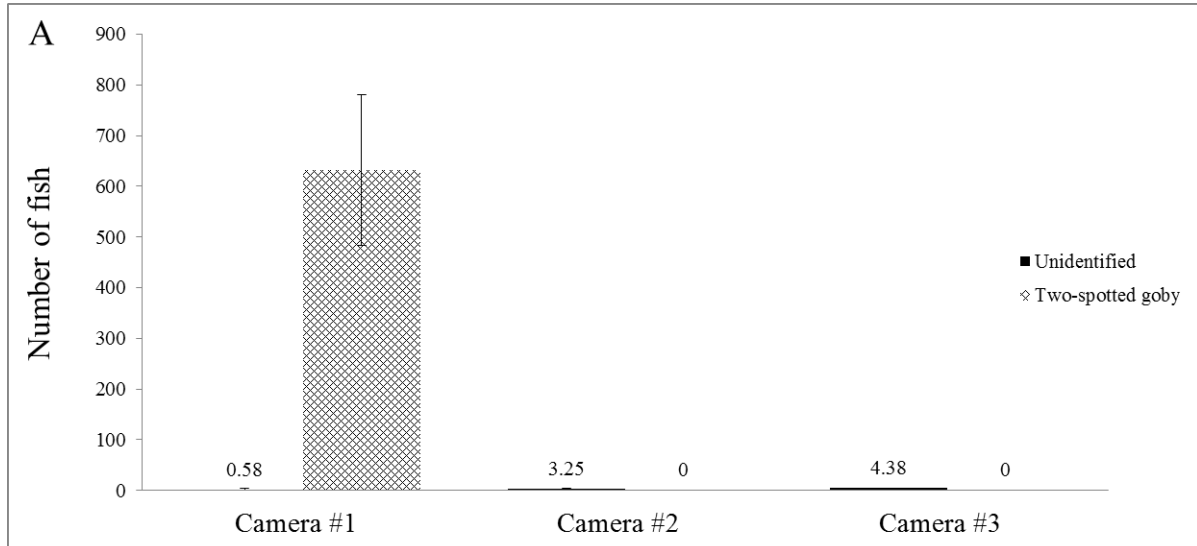

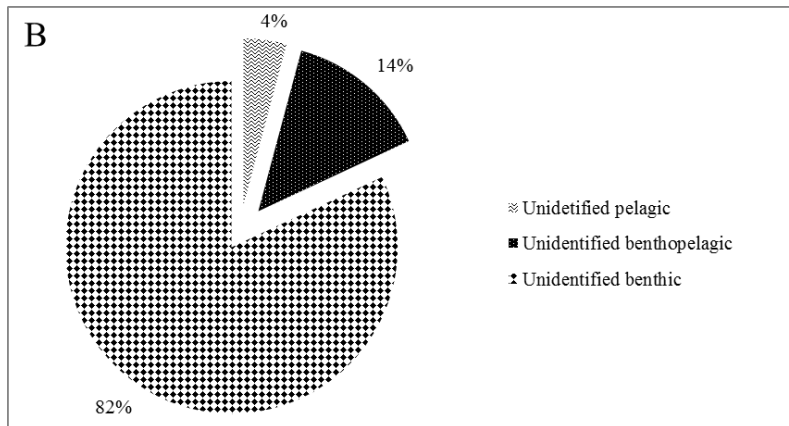

Figure 5A: Average abundance per filmed hour at Lillgrund. Figure show spatial variation as camera were placed 0, 25 and 50 m from turbine. No two-spotted gobies were observed at Camera #2 and #3.

Figure 5B: Percentage of abundant species besides two-spotted goby at Lillgrund. Numbers is average per filmed hour.

For Middelgrund the observations were also dominated by two -potted gobies both the presence of other fish were relatively larger compared to Lillgrund. The analysis was therefore carried out on the planned groups “two-spotted gobies”, “other species” and “not identified to species”.

For all taxonomic groups “distance” had a significant effect in the model ($p < .0001$). Highest numbers of fish was for “two-spotted gobies” seen at “0 m” but almost as high abundance was also seen at “50 m” (not significant difference between 0 and 50 m, $p > 0.58$). For “other species” and “not identified to species” higher number of fish was observed at “50 m”.

Time of day had a significant effect for “two-spotted gobies” ($p < .0001$) with highest abundance at “day” and “other species” ($p < 0.0002$) with highest abundance at “evening”.

Two-spotted goby which constituted 91.59 % of the total observed fish with StatCam at Middelgrund. Amount of unidentified pelagic species was larger for Middelgrund than for Lillgrund. Fish observed was mainly in the size range 1 to 10 cm with two exceptions of fish at approximately 15 cm. The large amount of fish categorized as unidentified pelagic is most likely gobies but were placed too far away from camera to be identify down to species level.

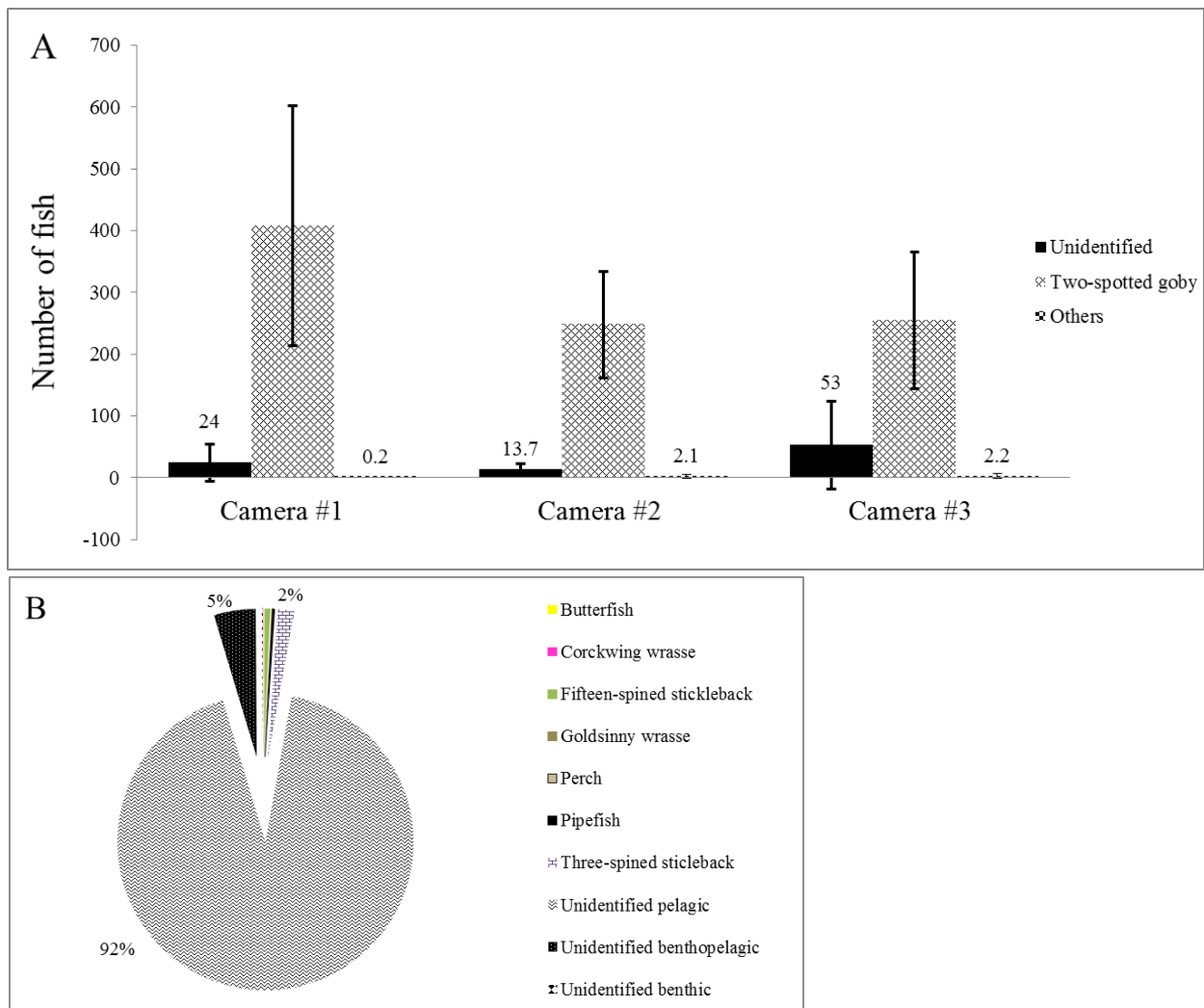

Figure 6A: Average abundance per filmed hour at Middelgrund. Figure show spatial variation as camera were placed 0, 25 and 50 m from turbine

Figure 6B: Percentage of abundant species besides two-spotted goby at Middelgrund. Numbers is average per filmed hour.

Daily variation of fish

There was an increase in abundance from sunrise until noon, followed by a decrease towards the sunset was seen at the camera stations with high fish densities (Figure 7A and B). Through the day species with length from 1 to 5 cm dominates. A total of 51 fish from 5 to 10 cm were observed when analyzing recorded data.

At Lillgrund there is only one full day of observations for Camera #2 and #3. Observations show a stable presence of two-spotted goby during a day around the turbine but with a small increase towards mid-day and decrease towards end of the day. At Lillgrund the record started just before sunrise at 7 a.m. but from Middelgrund there is no records started before 9 a.m. This gives a lack

of registrations from sunrise at Middelgrund. While for Lillgrund there is a whole day of registrations, from sunrise to sunset which shows a whole day of variation in fish abundance.

In the evenings fish disappear around the same time as the sun sets. For Lillgrund there are no registrations after 1700 hours and for Middelgrund at 2100 hours. Day length is shorter in end September and mid-October, than in the beginning of August when some of the sampling was done at Middelgrund.

Two-spotted goby was the most abundant species in both OWFs this is made as a category on its own when illustration the daily variation (Figure 7A and B).

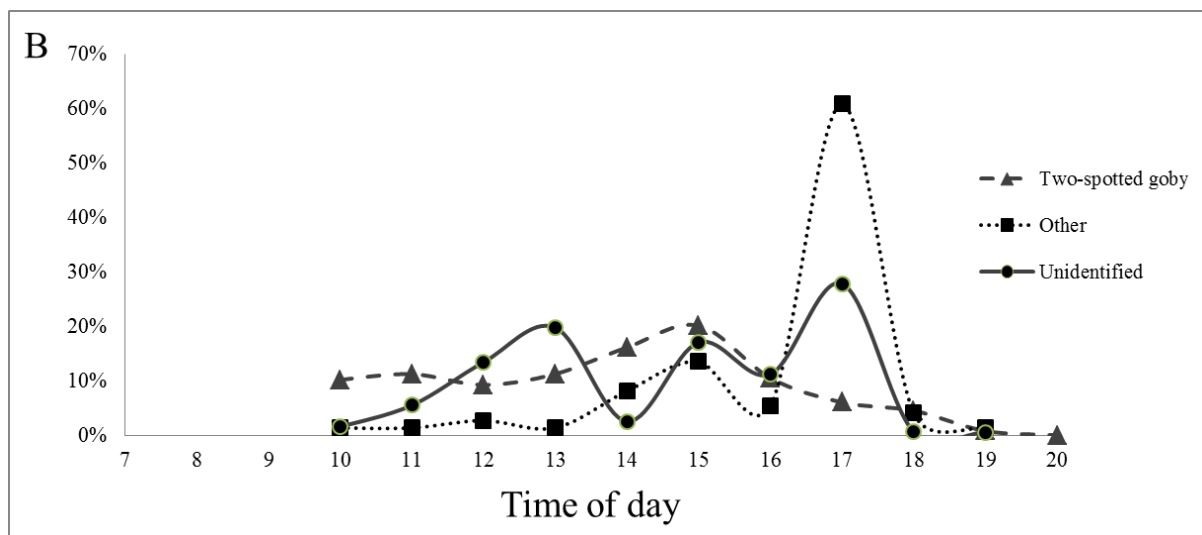
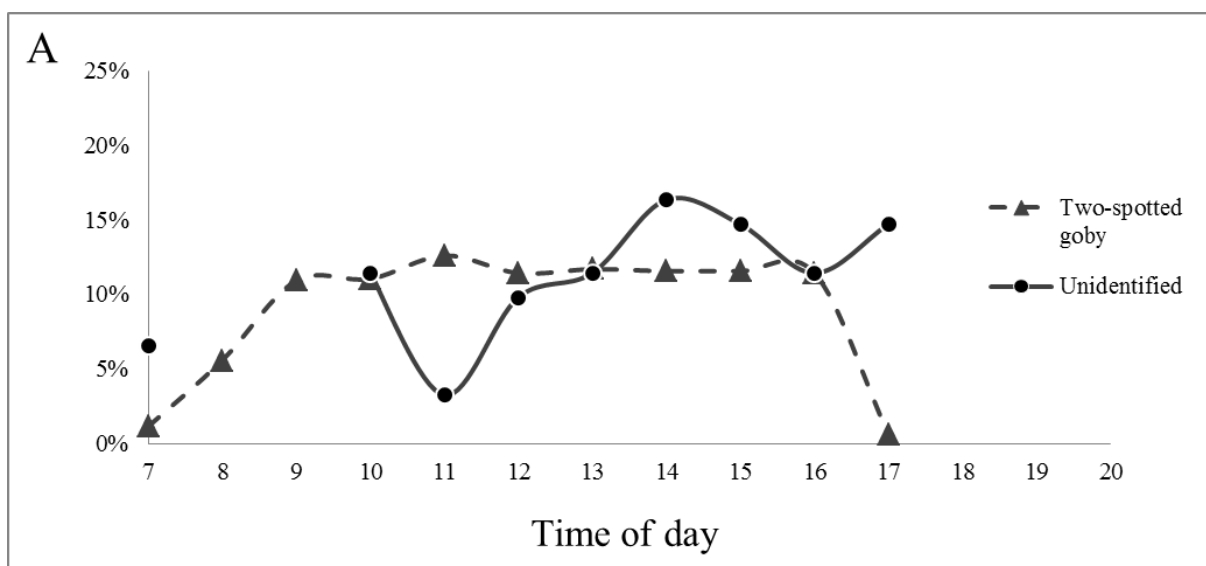

Figure 7A: Relative daily variation for two-spotted gobies for Camera #1 from Lillgrund, n = 12 007. Two-spotted gobies were not observed in Camera #2 and #3 at Lillgrund. Unidentified, n = 72.

Figure 7B: From Middelgrund: Relative daily variation for two-spotted gobies for Camera #1 with observed occurrence from August to October, n = 29 191. Two-spotted goby was the most numerous species caught on tape with StatCam for Lillgrund and Middelgrund. “Other” = butterflyfish (*Pholis gunnellus*, corckwing wrasse (*Symphodus melops*), fifteen-spined stickleback (*Spinachia spinachia*), goldsinny wrasse (*Ctenolabrus rupestris*), perch (*Perca fluviatilis*), three-spined stickleback (*Gasterosteus aculeatus*), (all by Linnaeus, 1758) and pipefish (*Syngnathus* sp.)) (n = 74). Unidentified, n = 2605. Note that value at Y-axis is not equal for figure A and B.

Turbine as shelter function

The analysis is somewhat hampered as fish only were observed at current velocities around 37 and 45 cm/s (Figure 8). With current velocity less than 45 cm/s the fish are absent from the current and shelter area (Figure 8A). With low current velocity less than 40 cm/s the fish does not show indications on leaving the turbine to seek areas with less current. From the film it is seen that the fish uses the turbine actively and is approximately 1 to 5 cm from the concrete when in the *Current* side of the turbine. There is no registration of currents from 55.2 to 72.1 cm/s, below 37 cm/s or above 95.3 cm/s. It is unknown how or if the fish uses the turbines for current shelter with these currents (Figure 8B).

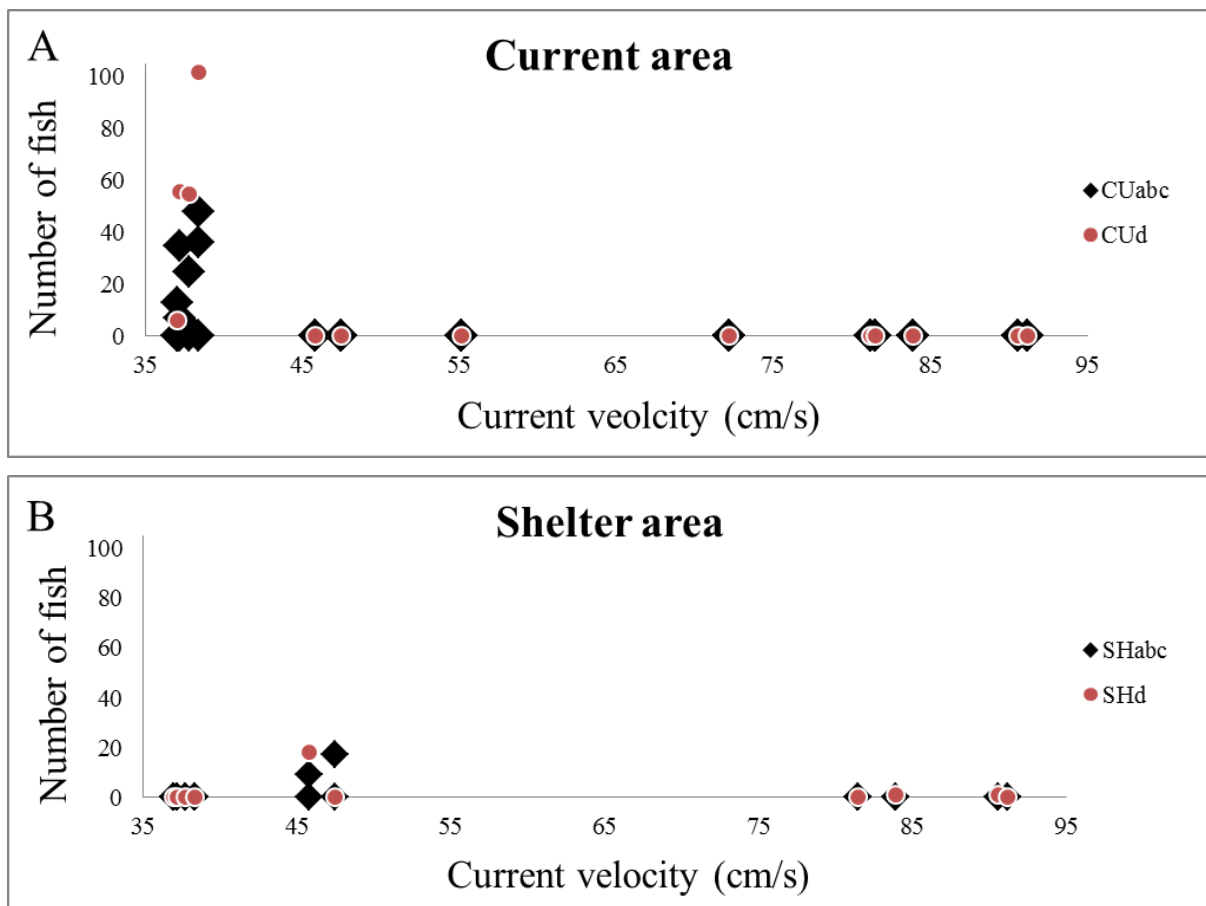

Figure 8A: Total amount of fish filmed in the *Current* area of a wind turbine in November. Data from Lillgrund and Middelgrund.

Figure 8B: Total amount of fish filmed in the *Shelter* area of a wind turbine in November. Data from Lillgrund and Middelgrund.

Discussion

In the present study it was shown that habitat surrounding each wind turbine in an OWF affects the spatial distribution of fish, mainly two-spotted gobies (*G. flavescens*). In areas with homogenous sandy seabed the turbine clearly attracts the fish. While for areas with varied substrate and sessile species as eelgrass the fish aggregation function of a turbine is not as significant. Wilhelmsson *et al.* (2006a) reported of a large aggregation of two-spotted gobies around turbine at 1 to 5 m and with a decreasing abundance at distances up to 20 m. Wilhelmsson *et al.* (2006a) and Öhman & Wilhelmsson (2005) showed that fish abundance was greater around the turbines than in the surrounding areas by using visual scuba census. And reported of mostly small fish at 1 to 5 cm size where two-spotted gobies were by far the most occurring species (Öhman & Wilhelmsson, 2005). Andersson and Öhman's (2010) study took place in an OWF with a heterogeneous habitat with boulders, stones and gravel/sand in surrounding area. These authors speculated whether their observed reef effects would be higher in areas where an OWF are placed in homogeneous areas with sand habitat thereby introducing habitat complexity to the area. The comparison done in present study at Lillgrund, with its homogenous habitat and significant differences in spatial fish densities, and at Middelgrund, with its more heterogeneous and non-significant difference in spatial fish abundance, were able to demonstrate this. Earlier studies show that fish is attracted to structures cutting vertical through water column with a decrease in abundance at increasing distance (e.g. dos Santos *et al.*, 2010; Løkkeborg *et al.*, 2002; Soldal *et al.*, 2002).

The cause behind enhanced fish abundance at structures in the sea has been debated in literature (e.g. Castro *et al.*, 2002; Hoffmann *et al.*, 2002; Leonhard *et al.*, 2011; Petersen & Malm, 2006; van Deurs *et al.*, accepted; Wilhelmsson *et al.*, 2006b). Is it simple behavior response of fish that result in a redistribution of the fish in a given area or is it because of enhanced biological production leading to an increase in fish abundance in a given area? Andersson (2011) suggest that two-spotted gobies in OWFs are a result of new production. This correlates with Perkol-Finkel & Benayahi (2006) showing that new reefs is adding species from surrounding area. Two-spotted gobies have been reported mainly to predate on planktonic copepods and hyper benthic

plankton (Costello *et al.*, 1990). This suggests that it might not be the high biological production that has been reported to occur on the turbines (Leonhard & Pedersen, 2006) but rather the hydrodynamics around the turbine increasing prey encounter and feeding success.

Hydrodynamics processes like turbulence has been shown to be positive for feeding and growth of larval and juvenile fish (e.g. Dower *et al.*, 1997; MacKenzie, 2000). This could explain why two spotted gobies were spread in the whole water column just adjacent to the turbine, but not observed to feed on the attached organism on the structure.

All the cameras in both OWFs showed a peak in fish abundance during mid-day. From Wilhelmsson *et al.*, (2006a) study it was expected that two-spotted gobies would be the dominating species. That study was done during the day (10 a.m. to 1700 hours) and did not provide any registrations after sunset. During night two-spotted gobies hide close to the seabed (Costello *et al.* 1990) probably to save energy and to seek protection from nocturnal predators. Larger fish and potential predators such as pipefish (*Syngnathus* sp.) and trout (*Salmo trutta* (Linnaeus, 1758)) was observed by StatCam one and four times respectively. At Lillgrund Bergström *et al.* (2009) observed potential predators such as cod (*Gadus morhua* (Linnaeus, 1758)) and whiting (*Merlangius merlangus* (Linnaeus, 1758)). Cod and perch (*Perca fluviatilis* (Linnaeus, 1758)) which is also potential predators were registered in gill net at Middelgrund catches, but never recorded (see my report Hansen, 2012). This shows that at least some additional predators enter the OWF at night. This observation is supported by Fabi & Sala (2002) and Soldal *et al.* (2002), showing an increase in predatory fish abundance in the night/early morning around an oil platform. However, it should be noted that larger species generally covers larger areas than small species (e.g. two-spotted goby) during a day. Consequently, the chances to record a picture of a predator with a stationary camera that cover a very restricted area must be relatively small.

Many fish were registered as *Unidentified* and categorized as either *pelagic*, *benthopelagic* or *benthic*. At Lillgrund *Unidentified benthic* was used a lot as the habitat observed 25 and 50 m from the turbine was sandy seabed, leaving little contrast for species identification. *Unidentified pelagic* were mostly used around the turbine where the fish used the whole water column.

One of the hypotheses was that the fish uses the turbine as shelter for current. For species like two-spotted goby feeding on planktonic copepods (Costello *et al.*, 1990) the fish will still be able to feed despite an increase in current velocity as they can seek shelter from the turbine.

Comparing the *Current* and *Shelter* areas of the turbine it is seen that the fish in the *Current* area

uses the turbine more actively as protection. In the *Current* area the fish was registered as close as 1 to 5 cm from the turbine, while in the *Shelter* area the fish were found further away from the turbine. Fish aggregates around the turbine at currents lower than 40 cm/s. At stronger currents the fish seems to be absent from the turbine area and are probably seeking towards the seabed for protection. But as the speed differences in this study is so low (35 to 47 m/s) it is hard to draw any firm conclusions on how the fish uses the turbine for current-shelter.

Camera approach provides valuable knowledge and more details on the small scale, compared to acoustic measurements and traditional fishing gears, and have a great potential for future biodiversity monitoring at offshore wind farms as well as natural habitats. Research done by Couperus *et al.* (2010) in an OWF illustrates the problem of survey results in the immediate vicinity of the turbine as to problems for a research vessel to approach the wind turbine. Visual census has been used a lot in this field of study (e.g. Öhman & Wilhelmsson, 2005; Wilhelmsson *et al.*, 2006a; Andersson & Öhman, 2010). Willis (2001) points out the underestimate of fish when diver uses visual census and the abundance of cryptic fishes. Combined with observed differences in some species compositions and abundance with presence of a diver, Dearden *et al.*, (2010) showed the necessity for camera control as well as diver or snorkeler. Assuming diver or snorkeler has good insight in species determination this method should be representative enough to be used for monitoring biodiversity but is dependent on species' behavior and environmental conditions (Fabi & Sala, 2002; Wendelin, 2011). Diving/snorkeling was showed in Wendelin (2011) to be most efficient during night. This is assumed to be due to nocturnal species being active in the period.

In conclusion it has been showed through this study that areas with homogeneous sand sediment has a higher impact on the fish fauna compared to OWF in areas with heterogonous sediment. The study found that the fish fauna near the wind turbines was dominated by two-spotted gobies, (*G. flavescens*) with a significant difference in spatial distribution at Lillgrund OWF. This suggests that the vertical structure of the wind turbine through the water column function as a fish aggregation point, dependent on the surrounding habitat. The hypothesis of fish using turbine as shelter for current cannot be confirmed or disproved with achieved results.

References

- Andersson, M. H. & Öhman, M. C. (2010) *Fish and sessile assemblages associated with wind-turbine constructions in the Baltic Sea*, Marine and Freshwater Research 61(6): 642-650.
- Andersson, M. H. (2011) *Offshore wind farms – ecological effect of noise and habitat alteration on fish*, Doctoral dissertation, Stockholm University.
- Azau, S., Casey, Z. (Eds.) (2011) *Wind in our Sails, The coming of Europe's offshore wind energy industry*, Report by the European Wind Energy Association, EWEA, Retrieved from www.ewea.org.
- Bergström, L., Lagenfelt, I., Sundqvist, F, Andersson, M. and Sigraay, P. (2009) *Fiskundersökningar veid Lillgrund*, Kontrollprogram för Lillgrunds vindkraftpark, Fiskeriverkets årsrapport 2009.
- Bracken, J. & Kennedy, M. (1967) *Notes on some Irish estuarine and inshore fishes*, Irish Fisheries Investigations, Series B (Marine), No. 3, Department of Agriculture and Fisheries (Fisheries Division).
- Castro, J. J., Santiago, J. A. & Santana-Ortega, A. T. (2002) *A general theory on fish aggregation to floating objects: An alternative to the meeting point hypothesis*, Fish Biology and Fisheries, 11: 255-277.
- Costello, M. J., Edwards, J. & Potts, G. W. (1990) *The diet of the two-spot goby, Gobiuscus flavescens (Pisces)*, J. mar. biol. Ass. U.K. 70: 329-342.
- Couperus, B., Winter, E., van Keeken, O., van Kooten, T., Tribuhl, S. & Burggraaf, D. (2010) *Use of high resolution sonar for near-turbine fish observations*, (DIDSON) – We@Sea 2007-02, Report number C138/10, IMARES Wageningen UR.
- Dearden, P., Theberge, M. & Yasué, M. (2010) *Using underwater cameras to assess the effects of snorkeler and SCUBA diver presence on coral reef fish abundance, family richness, and species composition*, Environmental Monitoring and Assessment, 2010, Volume 163, Numbers 1-4: 531-538.
- dos Santos, L. N., Brotto, D. S. & Zalmon, I. R. (2010) *Fish responses to increasing distance from artificial reefs on the Southeastern Brazilian Coast*, Journal of Experimental Marine Biology and Ecology 386: 54-60.

Not to be cited without prior reference to the author

Dower, J. F., Miller, T. J. & Leggett, W. C. (1997) *The Role of Microscale Turbulence in the Feeding Ecology of Larval Fish*, Advances in Marine Biology Volume 31: 169-220.

Fabi, G. & Sala, A. (2002) *An assessment of biomass and diel activity of fish at an artificial reef (Adriatic sea) using a stationary hydroacoustic technique*, IVED, Journal of Marine Science, 59: 411-420.

Hansen, K. S. (2012) *Small scale distribution of fish in offshore wind farms*, master thesis report, Copenhagen University and DTU Aqua.

Hoffmann, E., Astrup, J., Larsen, F., Munch-Petersen, S., Støttrup, J. (2002) *Effects of marine windfarms on the distribution of fish, shellfish and marine mammals in the Horns Rev area*, Ministeriet for Fødevarer, Landbrug og Fiskeri, Danmarks Fiskeriundersøgelser, DFU-rapport nr. 117-02.

Klaustrup, M. (2006) *Fish, Few effects on the fish communities so far*, In: Danish Offshore Wind –Key Environmental Factors, Report from DONG Energy, Vattenfall, The Danish Energy Authority and The Danish Forest and Nature Agency.

Leonhard, S. B. & Pedersen, J. (2006) *Benthic Communities at Horns Rev Before, During and After Construction of Horns Rev Offshore Wind Farm*, Final Report. Bio/consult.

Leonhard, S.B., Stenberg, C. & Støttrup, J. (Eds.) (2011) *Effect of the Horns Rev 1 Offshore Wind Farm on Fish Communities. Follow-up Seven Years after Construction*, DTU Aqua-report No 246-2011. Report commissioned by The Environmental Group through contract with Vattenfall Vindkraft A/S.

Løkkeborg, S., Humborstad, O-B., Jørgensen, T. & Soldal, A. V. (2002) *Spatio-temporal variations in gillnet catch rates in the vicinity of North Sea oil platforms*, ICES Journal of Marine Science, 59: S294-S299.

MacKenzie, B. R. (2000) *Turbulence, larval fish ecology and fisheries recruitment: a review of field studies*, Oceanologica Acta, Vol. 23(4): 357-375.

Öhman, M.C. & Wilhelmsson, D. (2005) *VINDREV – Havsbaserade vindkraftverk som artificiella rev: effekter på fisk*, Vindforsk, FOI/Energimyndigheten. Report from University of Stockholm.

Not to be cited without prior reference to the author

Perkol-Finkel, S. & Benayahu, Y. (2006) *Differential recruitment of benthic communities on neighboring artificial and natural reefs*, Journal of Experimental Marine Biology and Ecology 340: 25-39.

Petersen, J. K. & Malm, T. (2006) *Offshore Windmills Farms: Threats to or Possibilities for the Marine Environment*, Ambio, 35(2): 75-80.

Santos, M. N., Monteiro, C. C. & Lassère, G. (1996) *Finfish attraction and fisheries enhancement on artificial reefs: a review*, In: Jensen A. C (Ed.) (1997) *European Artificial Reef Research*, Proceedings of the 1st EARRN conference, Ancona, Italy, March 1996, Pub, Southampton Oceanography Centre.

Soldal, A. V., Svellingen, I., Jørgensen, T. & Løkkeborg, S. (2002) *Rig-to-reefs in the North Sea: hydroacoustic quantification of fish in the vicinity of a "semi-cold" platform*, ICES Journal of Marine Science, 59: S281-S287.

van Deurs, M. Grome, T. M., Kaspersen, M., Jensen, H., Stenberg, C., Sørensen, T. K., Støttrup, J., Warnar, T. & Mosegaard, H. (accepted) *Short-term and long-term effects of an offshore wind farm on three species of sandeel and their habitat*, Marine Ecology Progress Series.

Wendelin, K. (2011) *Snorkeldykning som observationsmetode til monitering af biodiversitet*, Bachelorprojekt, Det Biovidenskabelige Fakultet LIFE, Københavns Universitet.

Wilhelmsson, D., Malm, T. & Öhman, M.C. (2006a) *The influence of offshore windpower on demersal fish*, ICES Journal of Marine Science, 63: 775-784.

Wilhelmsson, D., Yahya., S, Öhman, M. C. (2006b) *Effects of high-relief structures on cold temperate fish assemblages: A field experiment*, Marine Biology Research, 2: 136-147

Willis, T. J. (2001) *Visual census methods underestimate density and diversity of cryptic reef fishes*, Journal of Fish Biology 59: 1408-1411.

Appendix

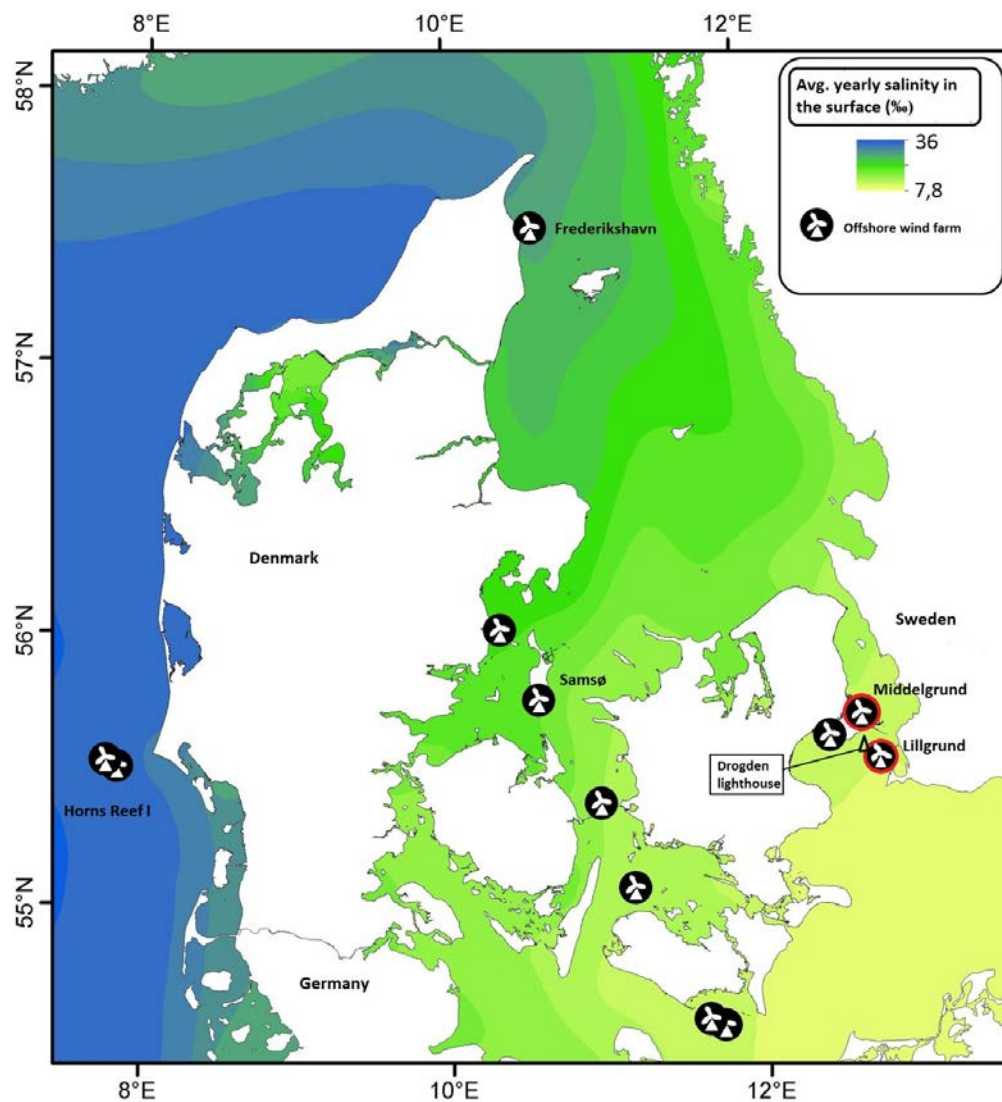

Figure 9: Salinity map for the Danish waters. Shows average salinity through the year. Black and white wind turbine sign symbolizes where the OWFs are placed in Danish waters. Lillgrund and Middelgrund marked with red circle. Drogden lighthouse where current-information was registered is placed between Lillgrund and Middelgrund, marked as a triangle. Map by Morten Aabrink, DTU.

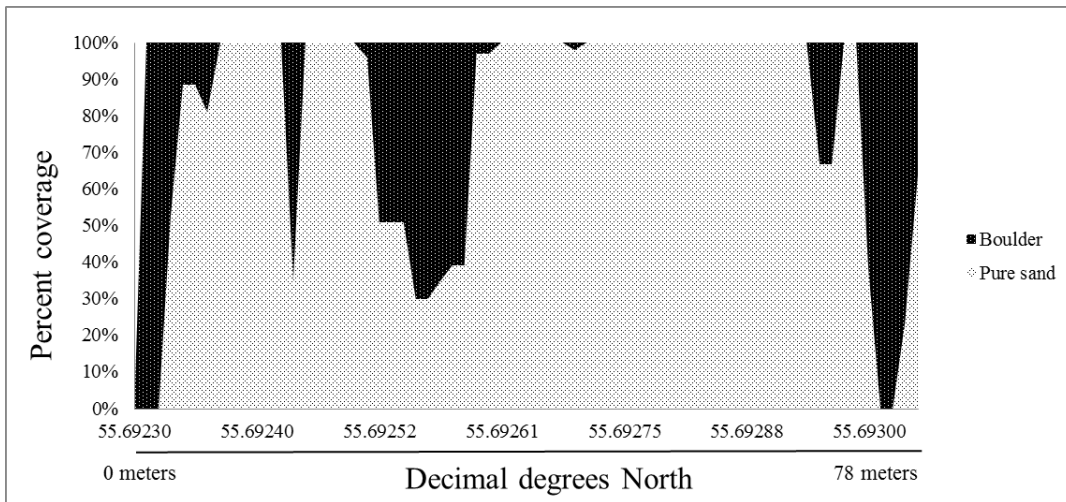

Figure 10: Seabed transect that gives indication of the amount of boulder in the Middelgrund wind farm.

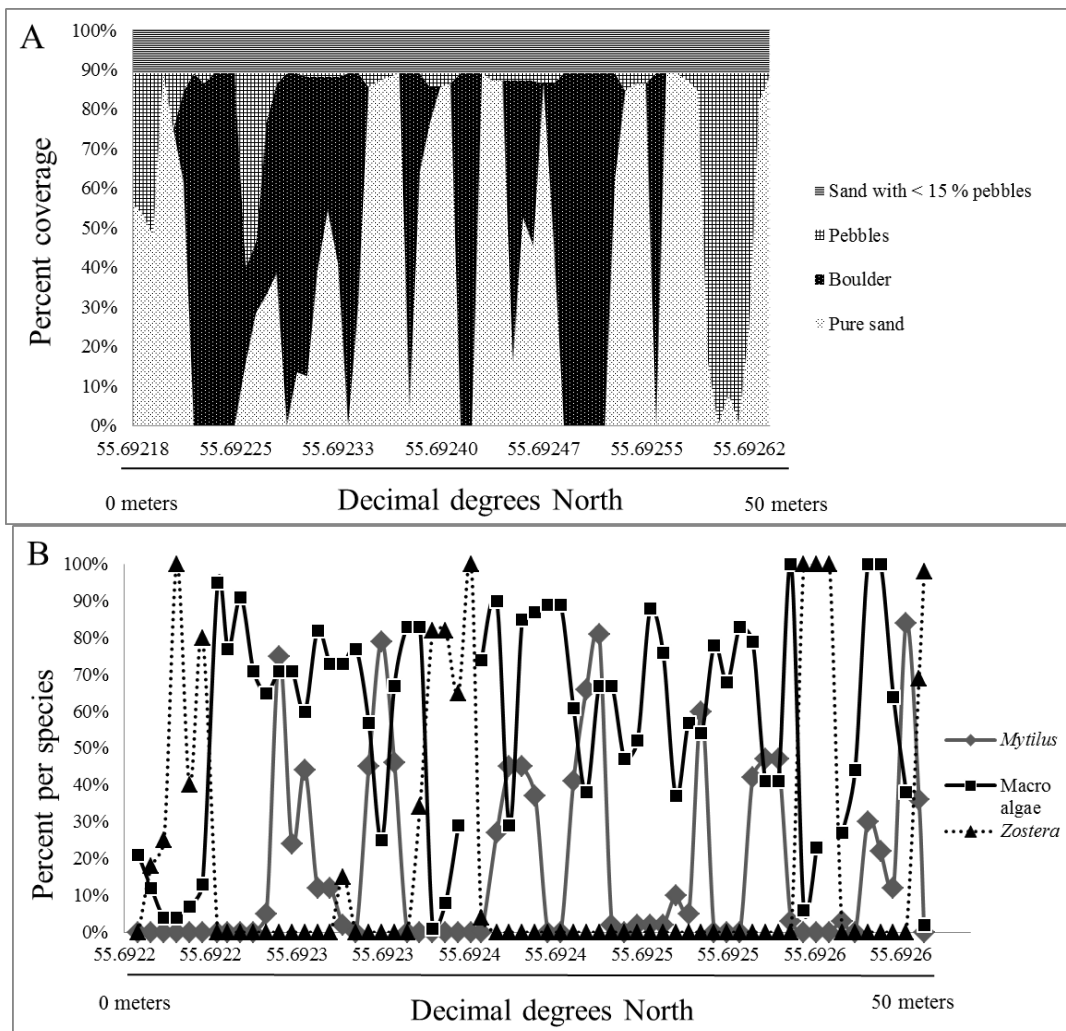

Figure 11A and B shows the diversity that can be found in Middelgrund OFW with both substrate and species.