

# MHK and Electromagnetic Fields (EMFs)

U.S. DEPARTMENT OF  
**ENERGY**

Energy Efficiency &  
Renewable Energy



## MHK Regulator Workshop: Washington DC

May 5-6, 2015

Andrew B Gill

# Introduction - MHK and Electromagnetic Fields (EMFs)

Andrew B Gill PhD,  
Senior Lecturer



Co-Chair, ICES Working Group on  
Marine Benthos and Marine Renewable Energy Developments



# What we know about EMF

Known  
Known

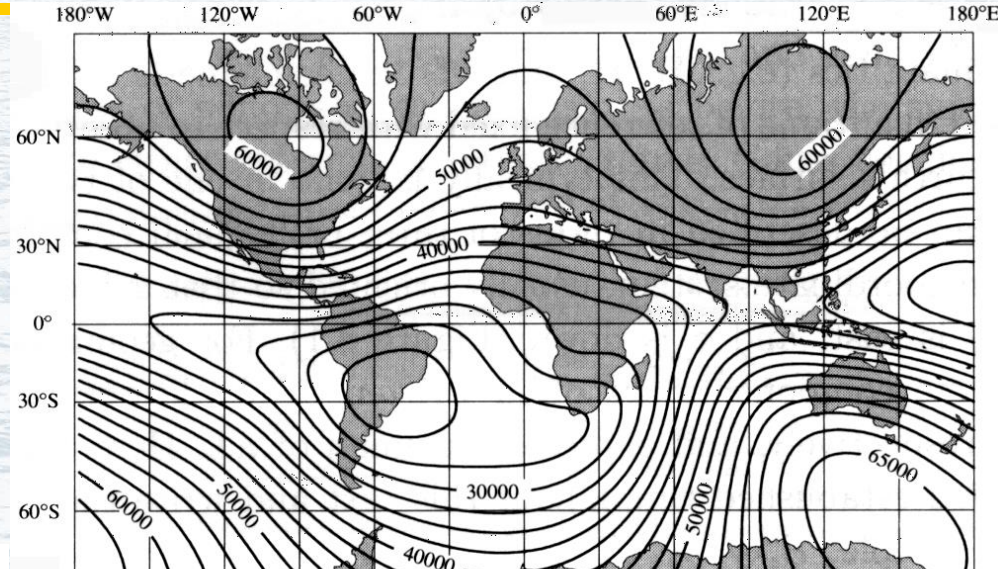
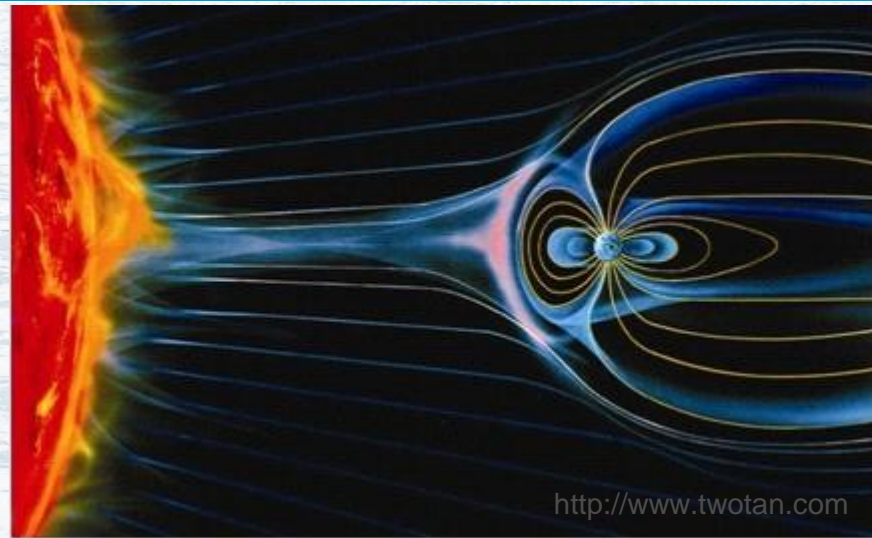

[http://geophysics.ou.edu/solid\\_earth/notes/mag\\_earth/magnetic\\_field\\_a.gif](http://geophysics.ou.edu/solid_earth/notes/mag_earth/magnetic_field_a.gif)

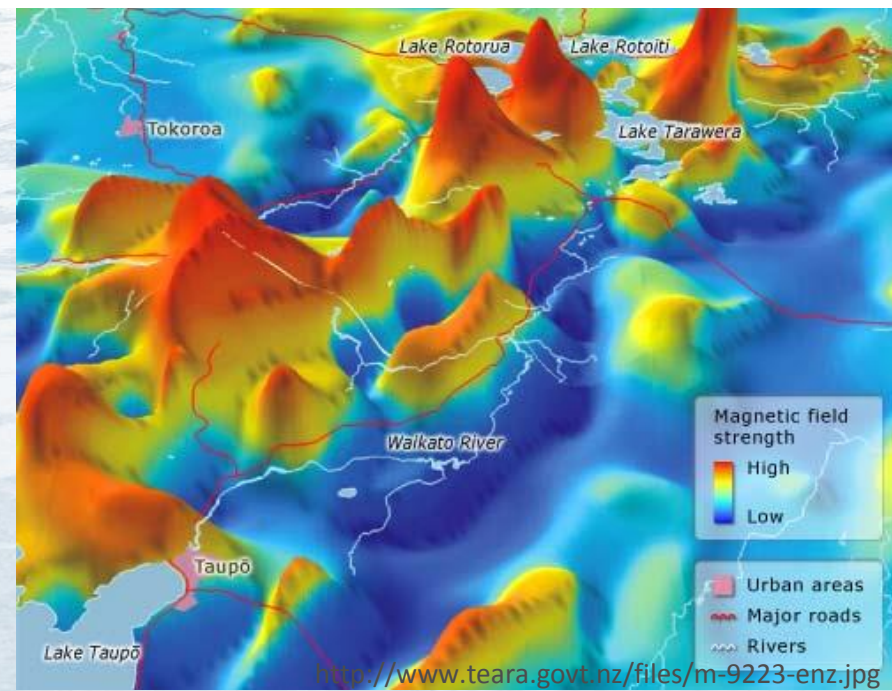
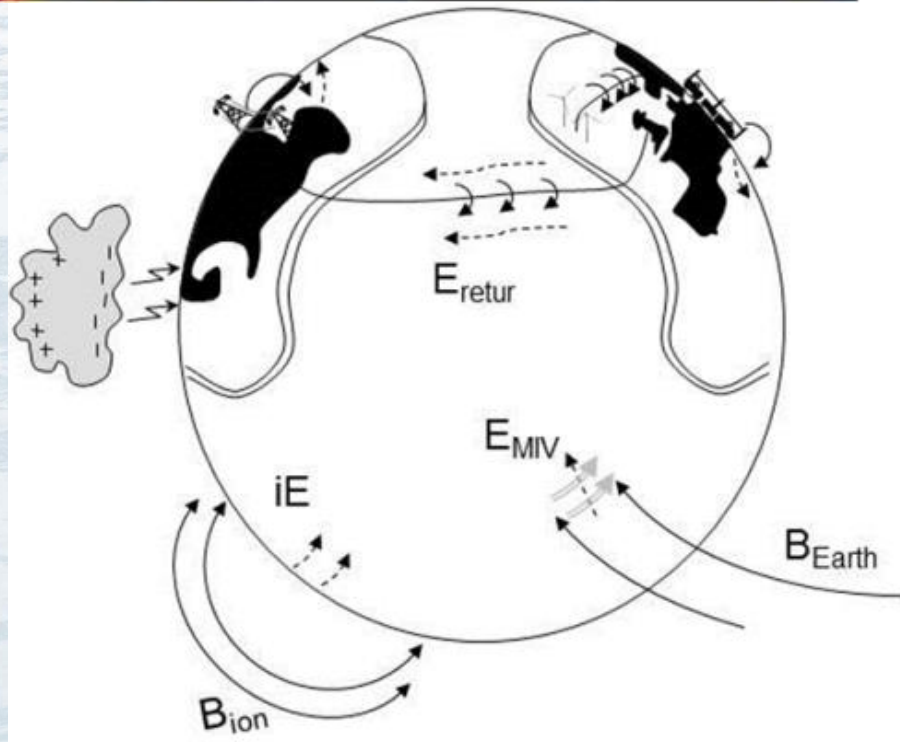

# What we know about EMF

- Ability to sense and respond to EMF is widespread across taxonomic groups, ranging from bacteria to whales.

Interest tends to be focussed on:

- elasmobranchs (sharks, skates and rays)
- agnatha (lampreys)
- crustacea (lobsters and prawns)
- mollusca (snails, bivalves, cephalopods)
- cetacea (whales and dolphins)
- bony fish (teleosts and chondrosteans ) and
- marine turtles

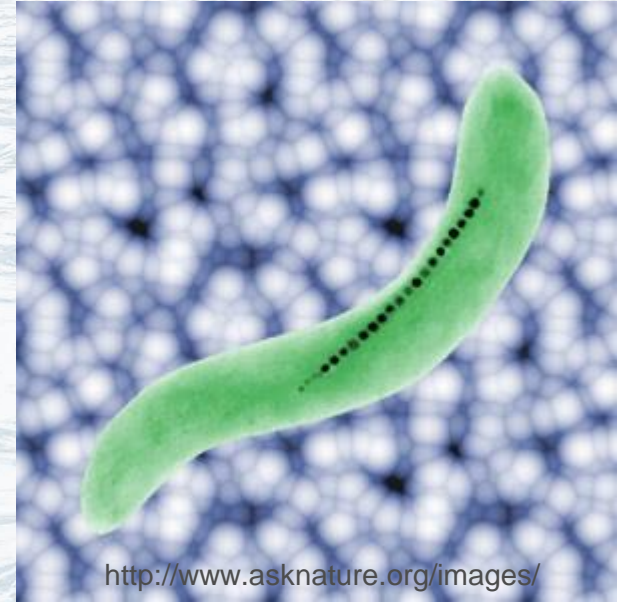

# Marine Renewable Energy Devices (incl. MHK)

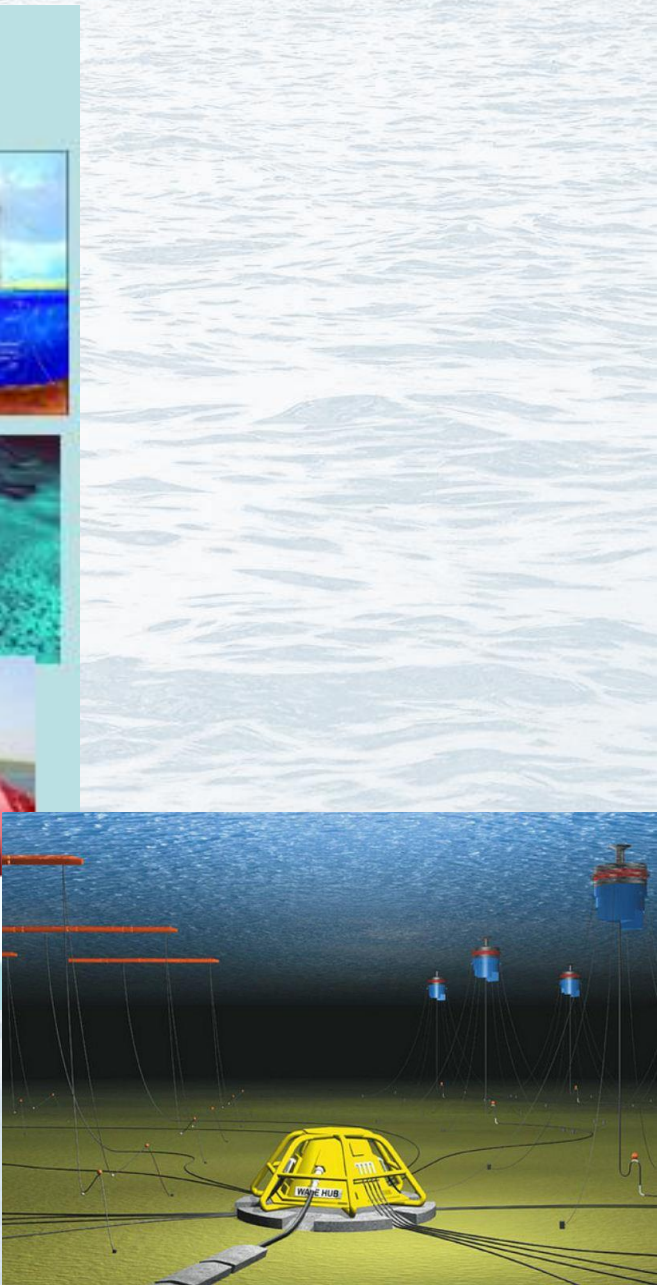
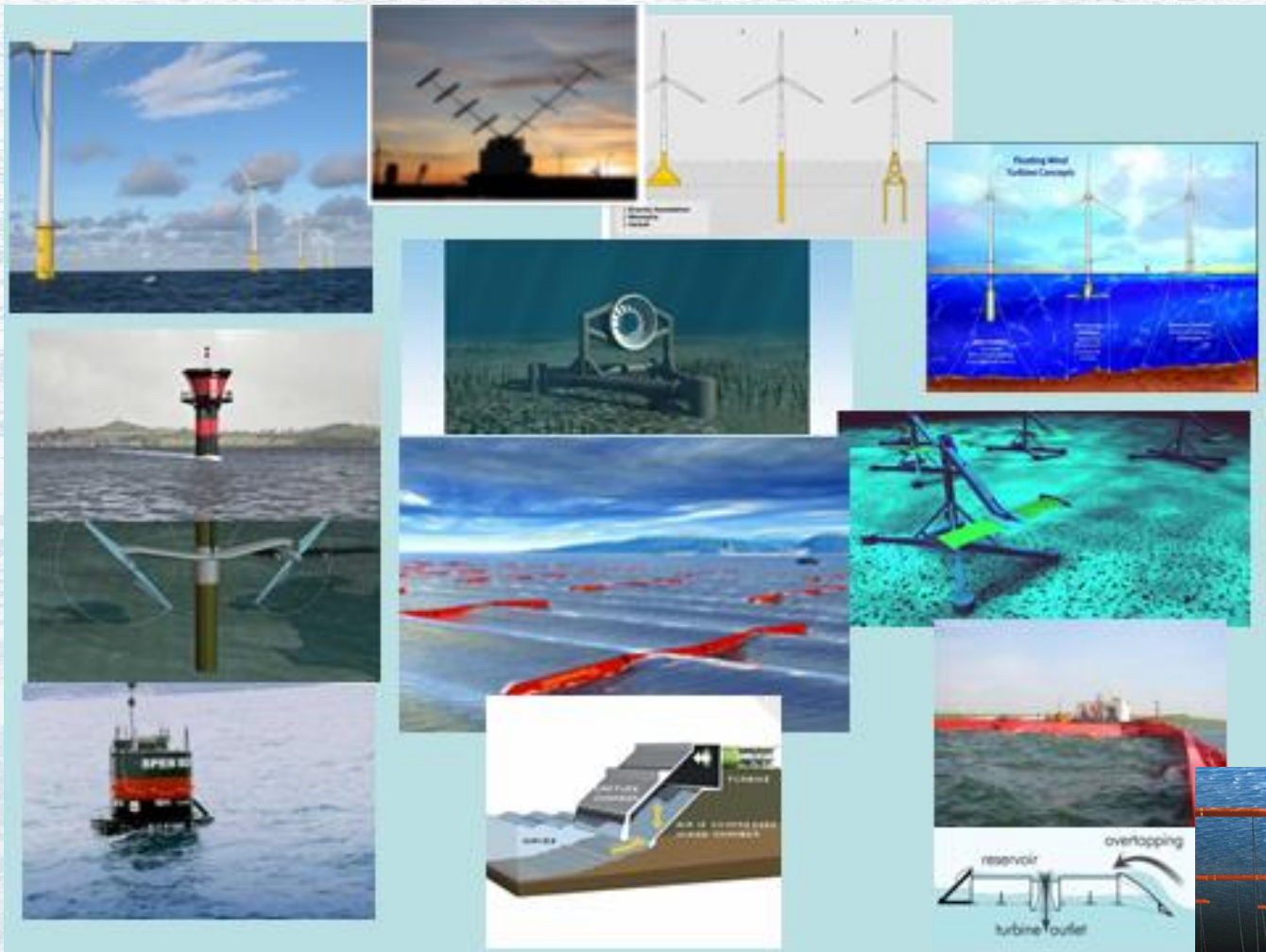

# Typical subsea power network

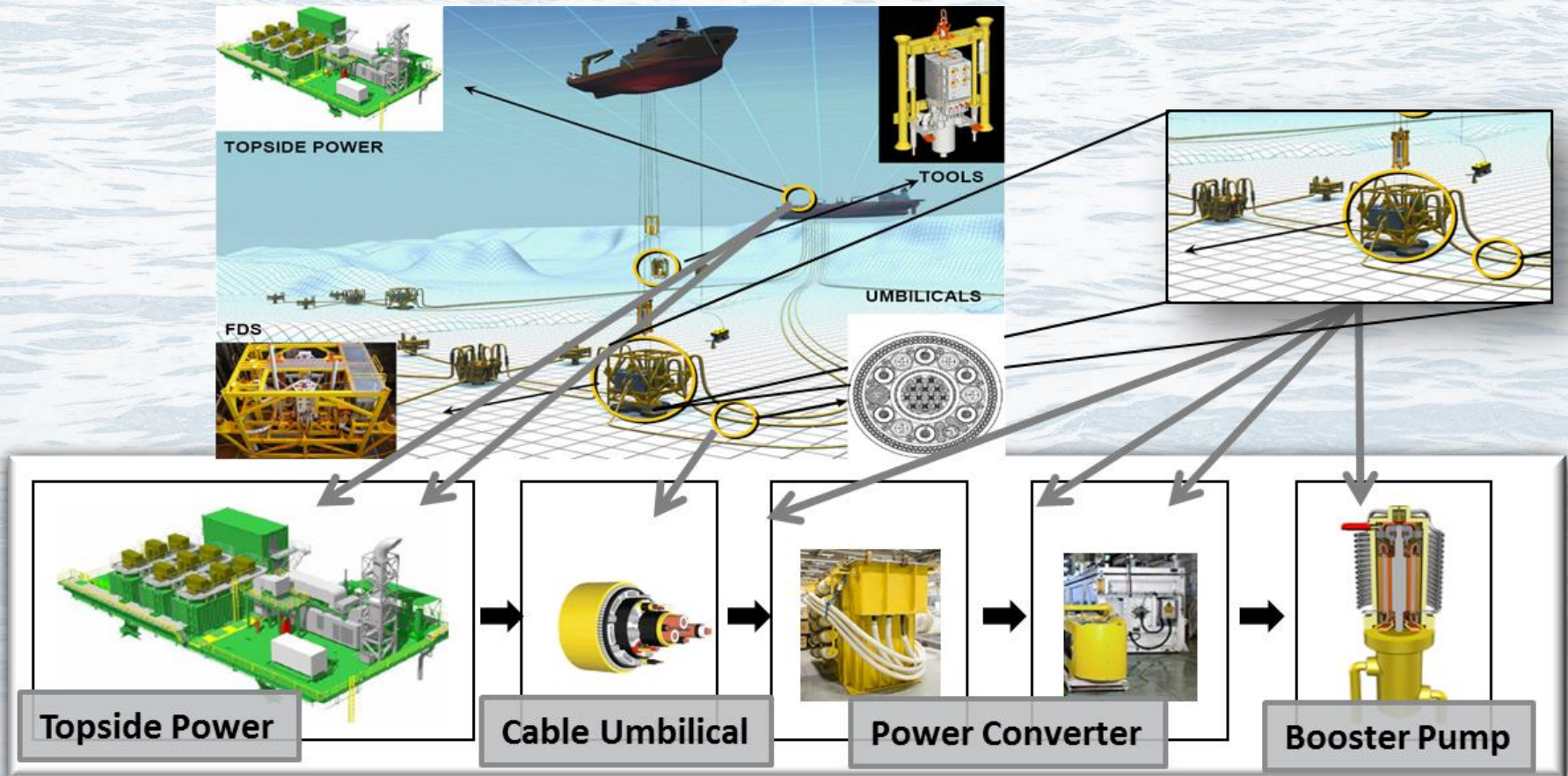

An example of subsea power distribution network (Figure courtesy: ANSYS)

# Schematic of MRED power network

Known  
Known

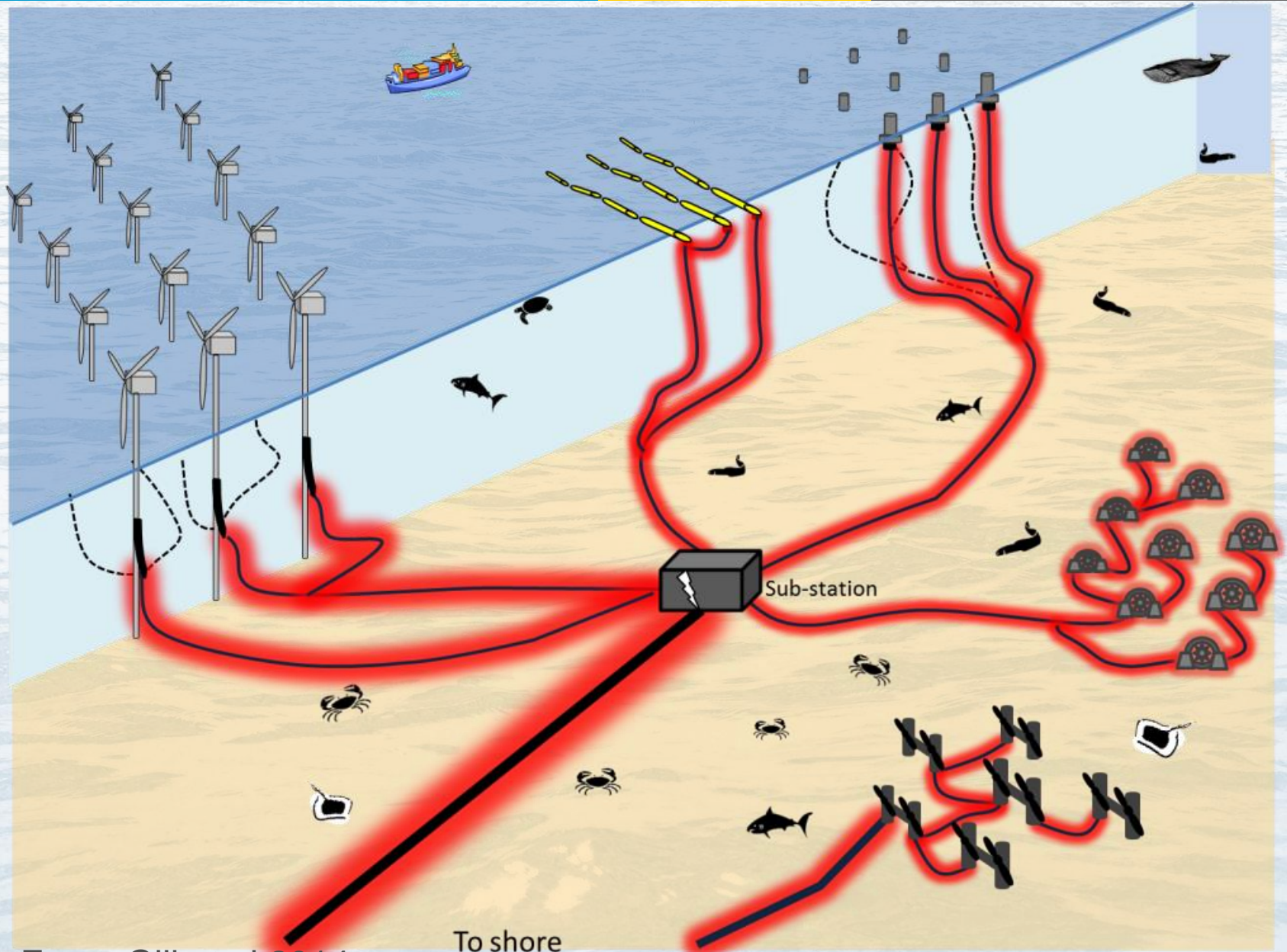

# Operation - Electromagnetic field (EMF) emissions from subsea cables - predicted

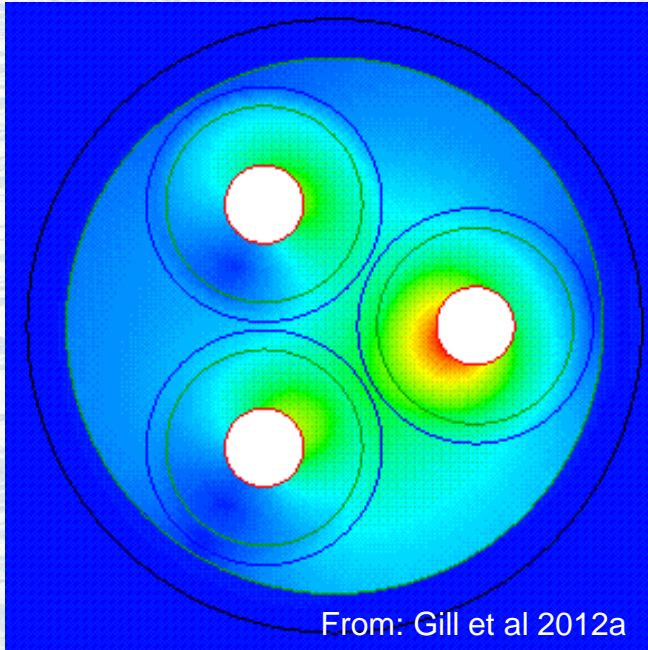

X-section AC cable (internal) – magnetic field

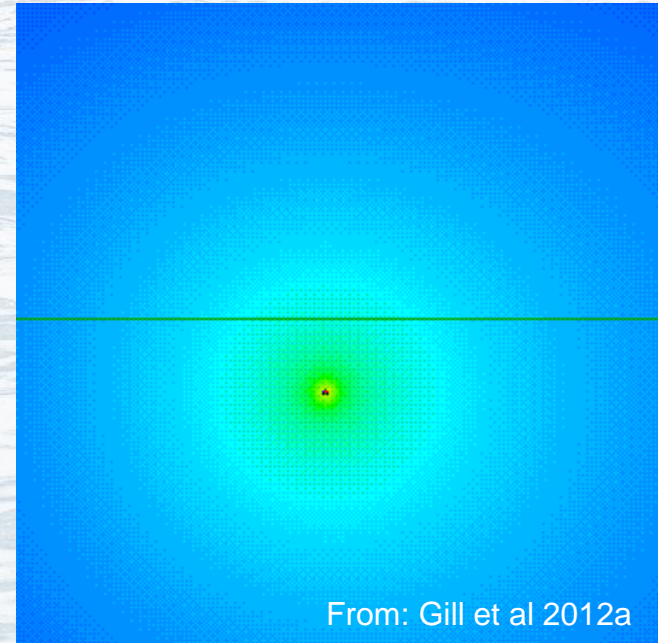

X-section cable (external) - magnetic field

**A.C. – time varying**  
**D.C. – static (i.e. 0 or 1)**



# EMF dissipation

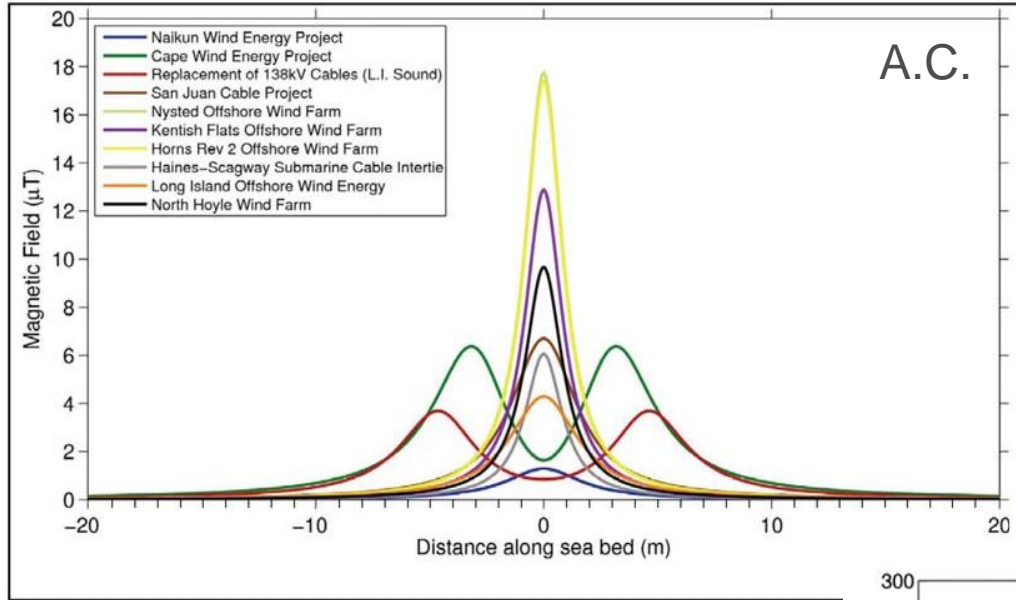

From: Normandeau et al 2011

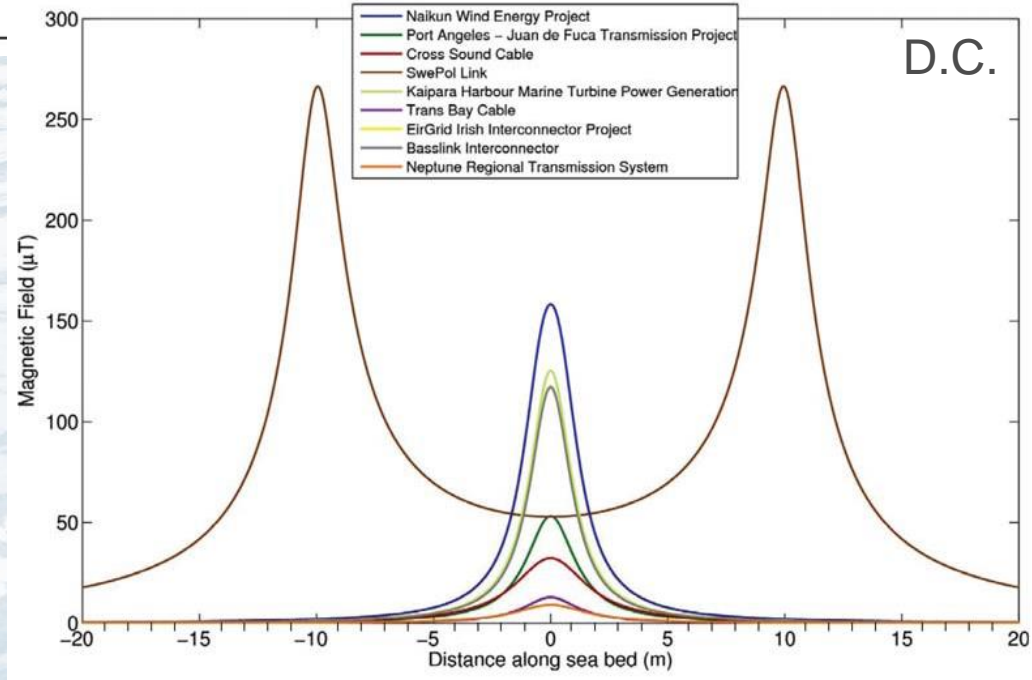

# Defining the EMF – AC and DC

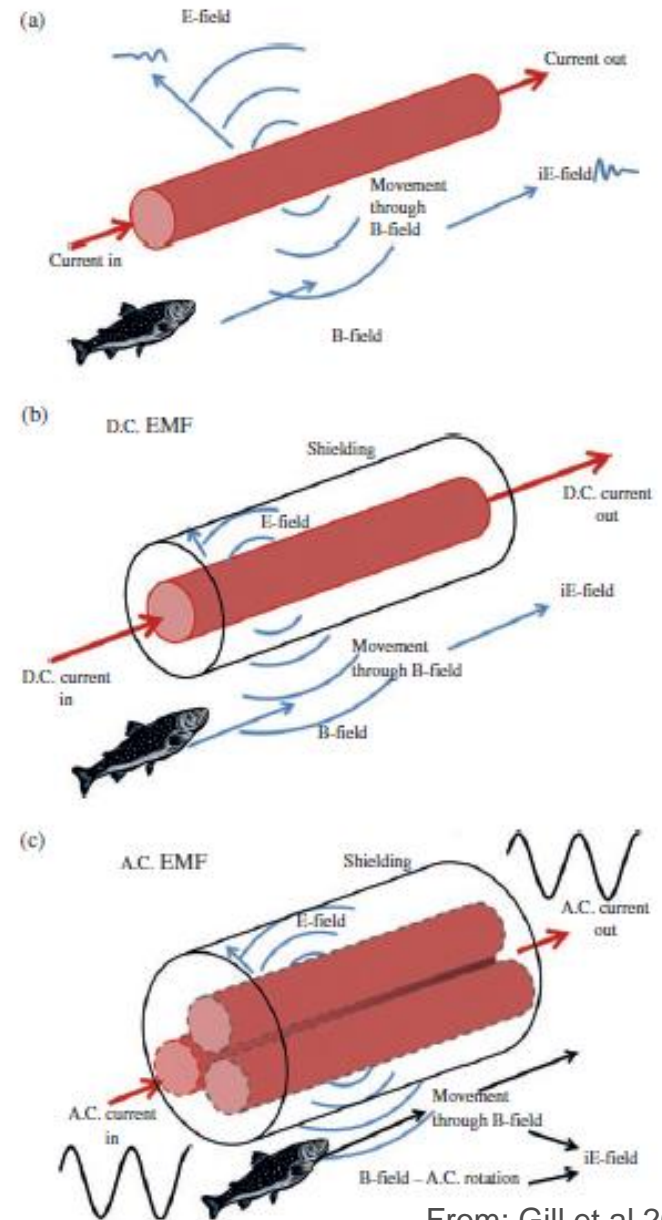
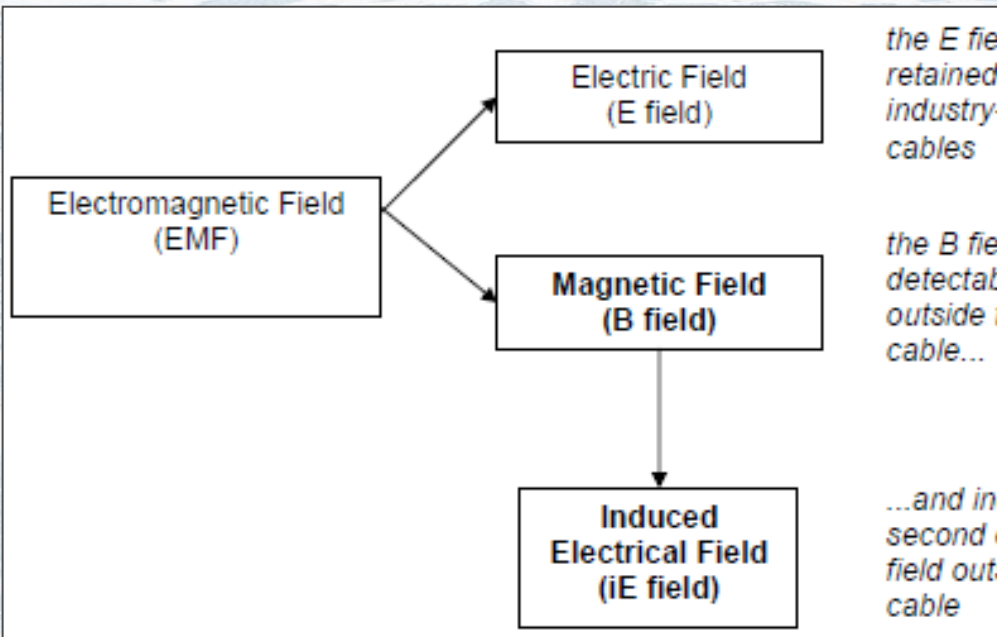

From: Gill et al 2012b

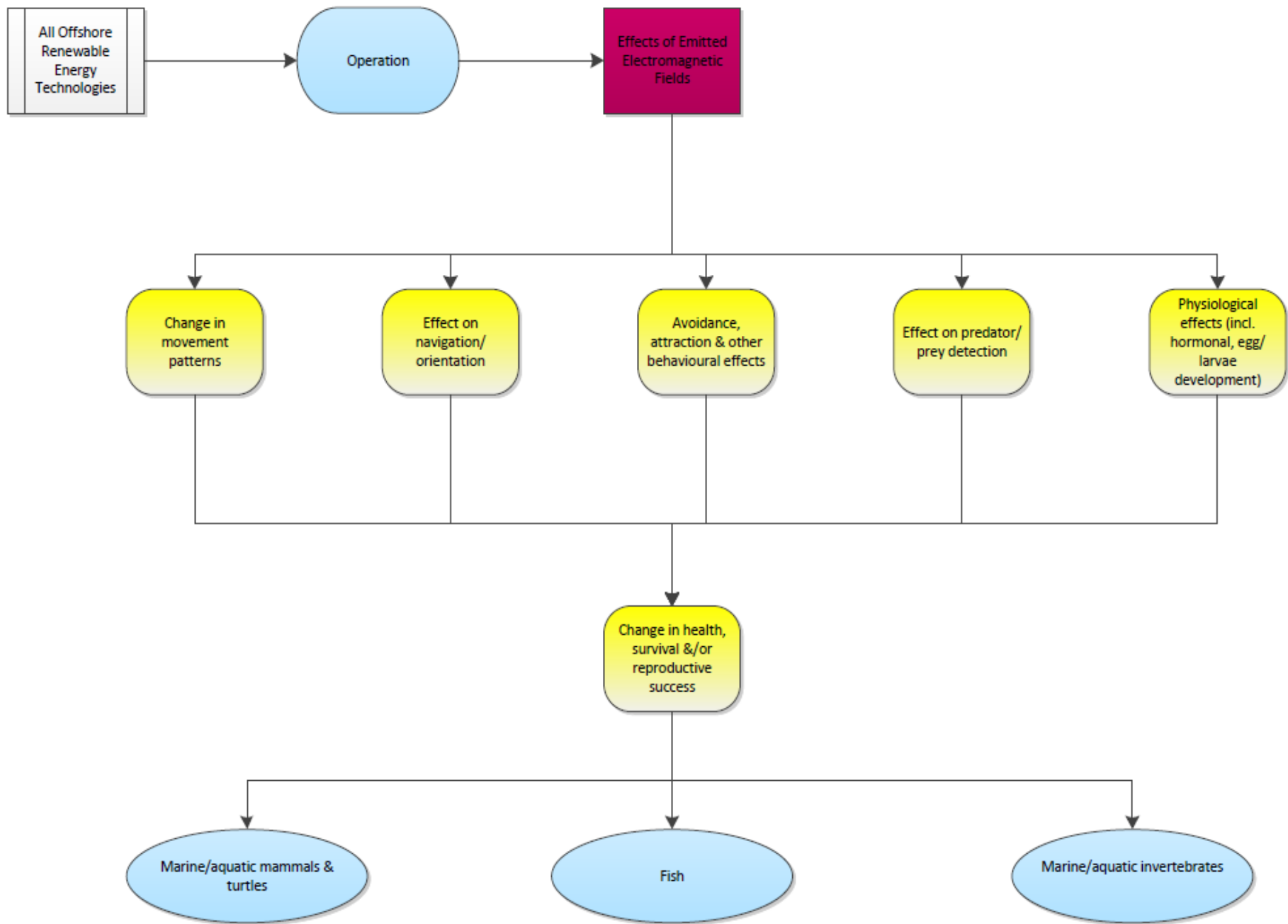

Figure 7: PoE Model for Electromagnetic Field Stressor in Operations Phase (from: Isaacman & Daborn, 2011)

# Measured and Observed Impacts of Electromagnetic Fields (EMFs)

Known  
Known

- Electrosensitive species can detect EMFs both DC and AC cables with higher sensitivity to DC cables. Most highly sensitive taxa -elasmobranchs and jawless fish (Agnathans)
- Magnetosensitive species are likely to be able to detect EMFs from DC cables and potentially AC cables, but to a lesser degree
- Behavioural responses, such as attraction to EMFs from subsea cables, have been demonstrated but extrapolation to impacts of MRED power cables on sensitive receptors would be speculative
- As the main source of the EMF is the cable, benthic and demersal species, which are closer to the source, are considered to be more likely to be exposed to higher field strengths than pelagic species.

## ***PNNL + Oakridge lab studies:***

- Coho salmon alarm response experiments identified some decreased swimming activity
- Hormonal tests did not give any evidence of stress, but some decreases in melatonin levels in Coho salmon
- Rainbow trout eggs exposed to EMF of 3mT showed some developmental delay
- Atlantic halibut showed reduced growth and development following late exposure to EMF of 3mT
- However no noticeable effects on growth or development of California halibut

# Sensory behaviour - lab study

Known  
Known

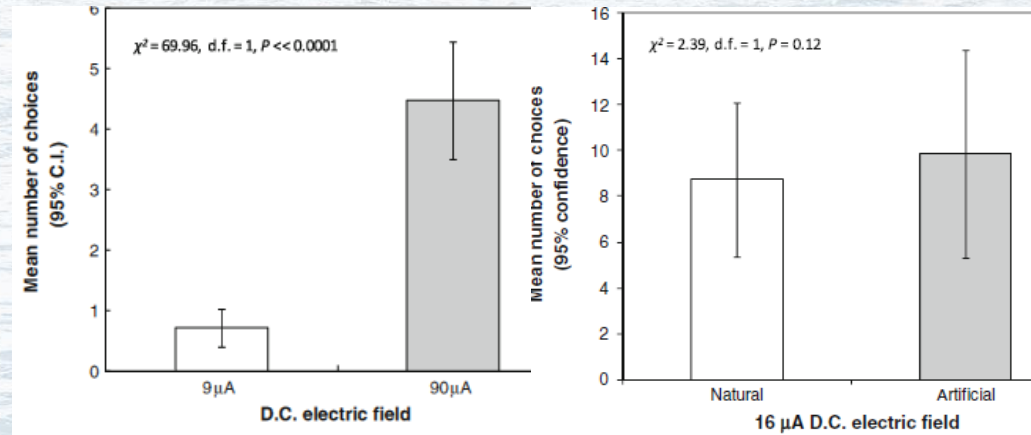
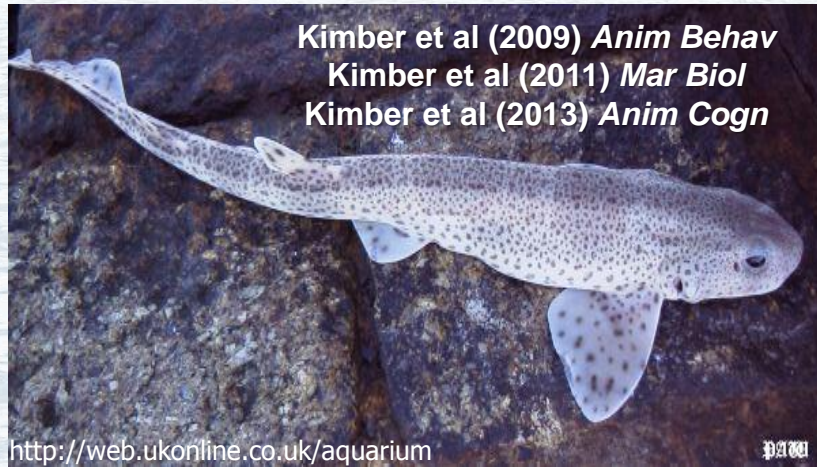

Before interval: UNREWARDED

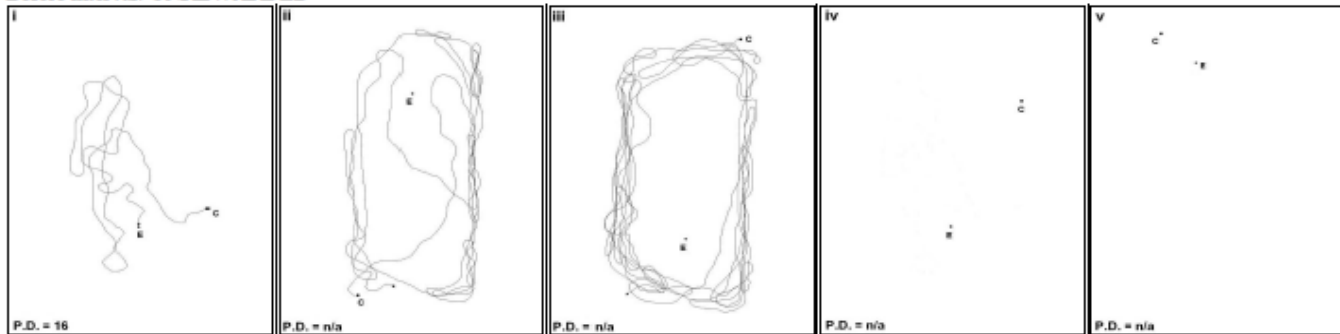

After interval: REWARDED

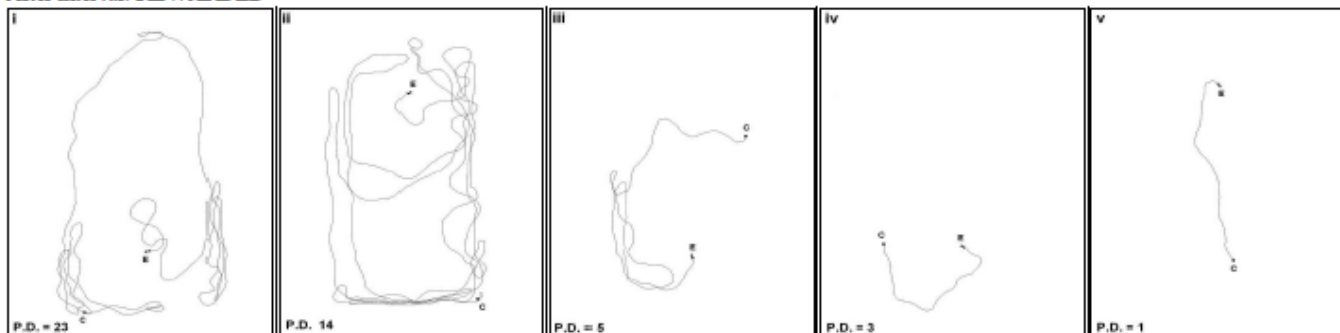

Catshark Blue 1501

# Taking the lab into the field

Note: not to scale

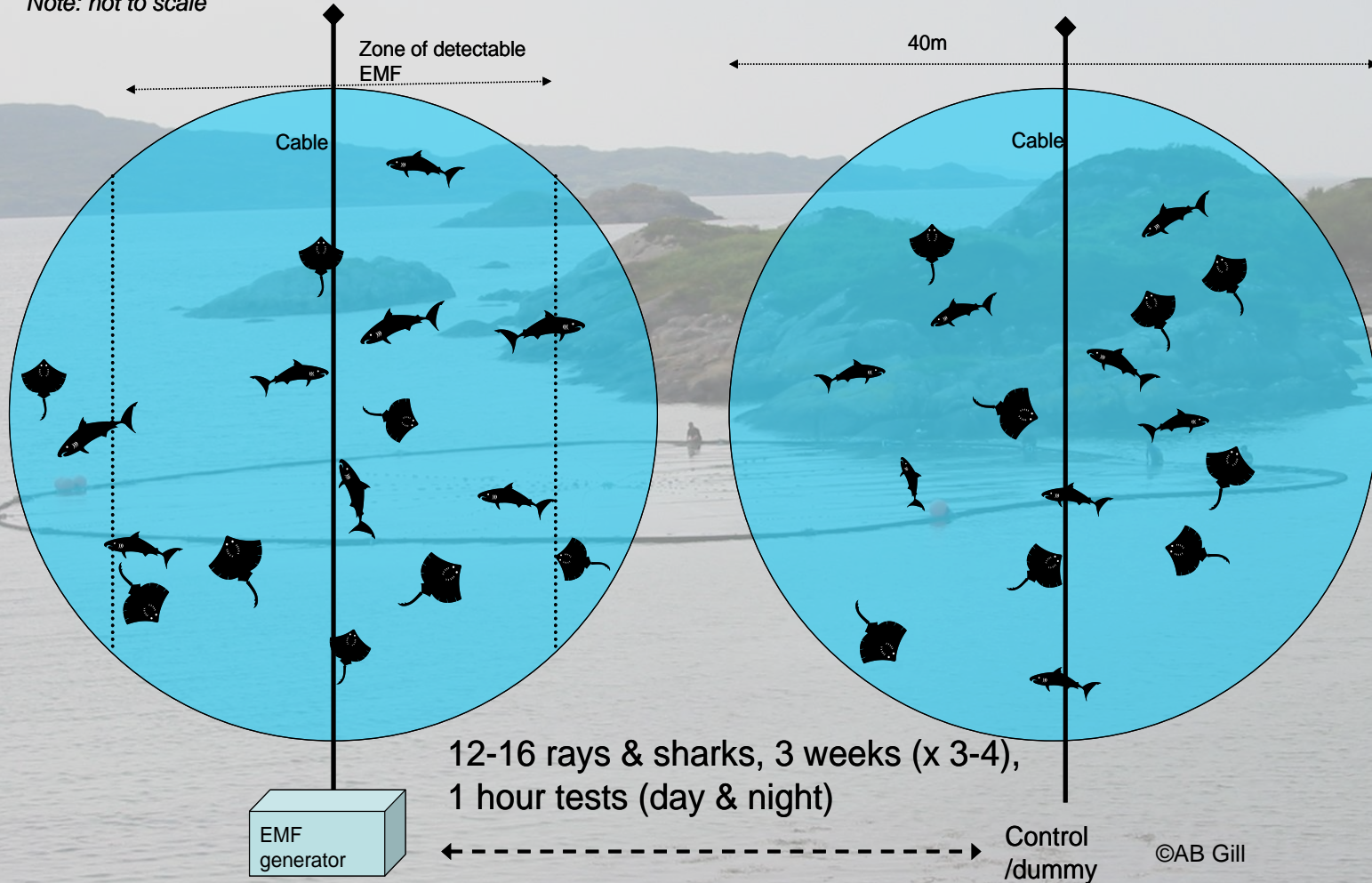

# Taking the lab into the field - results

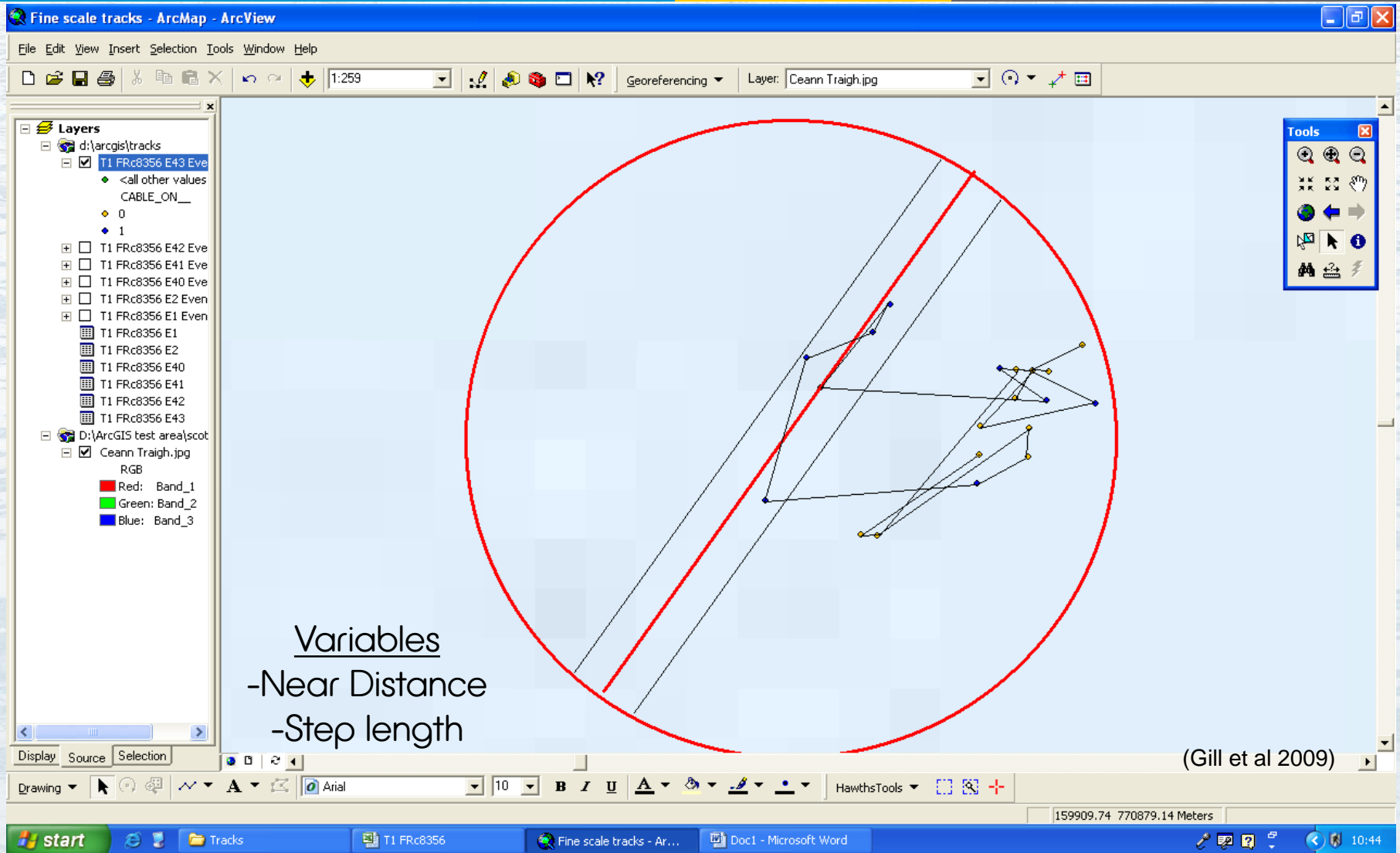

- Benthic catshark non-random distribution - more likely in cable zone when energised. (Gill et al 2009)

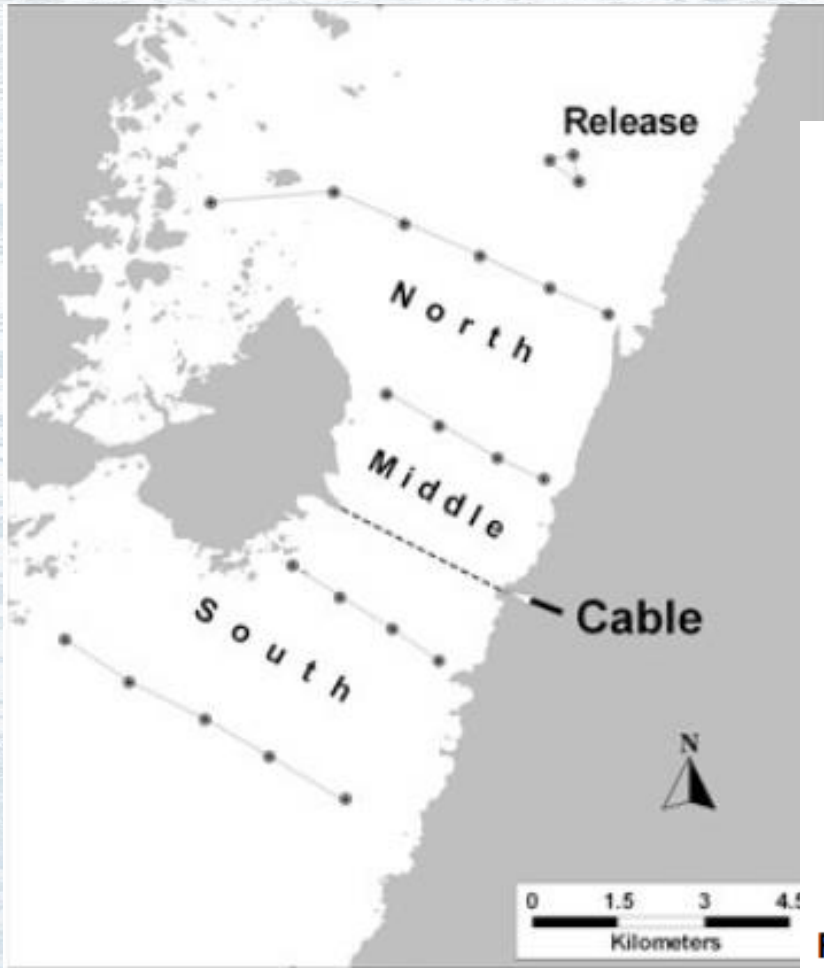

Westerberg & Lagenfelt 2008

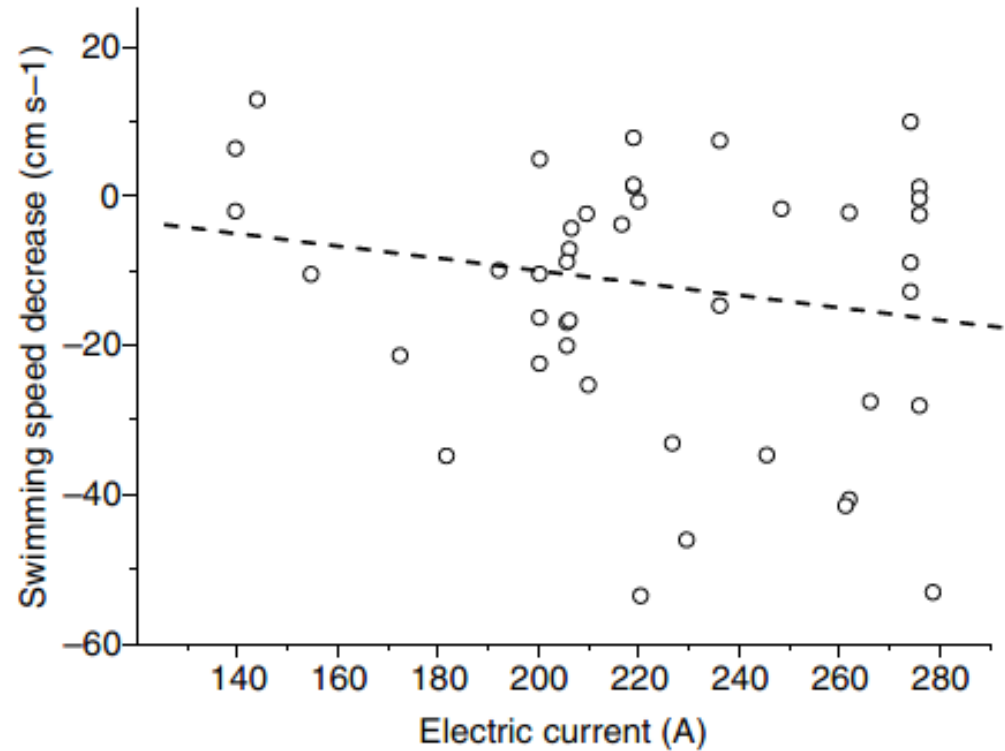

**Figure 5.** Linear regression of speed deficit and the simultaneous, root mean square, current in the sub-sea cable. The deficit is the decrease of swimming speed in the middle (cable) interval compared with the mean swimming speed of the same eel in the northern and southern intervals.



## What we know about EMF

- Some studies (field, experimental and anecdotal) that indicate response to cables (D.C. and A.C.)
- Extremely low confidence in knowledge about any actual impacts (effect v impact)
- Results are generally applicable to other MHK technologies and devices - scalable

## Regulatory drivers (e.g.)

- EU's Marine Strategy Framework Directive (MSFD) for inputs of energy Article 11
  - 'Introduction of energy, including underwater noise, is at levels that do not adversely affect the marine environment'*
- MHK Annex IV & Tethys – EMF status within EIAs

# MaRVEN: Environmental Impacts of Noise, Vibrations and Electromagnetic Fields from Marine Renewable Energy Developments

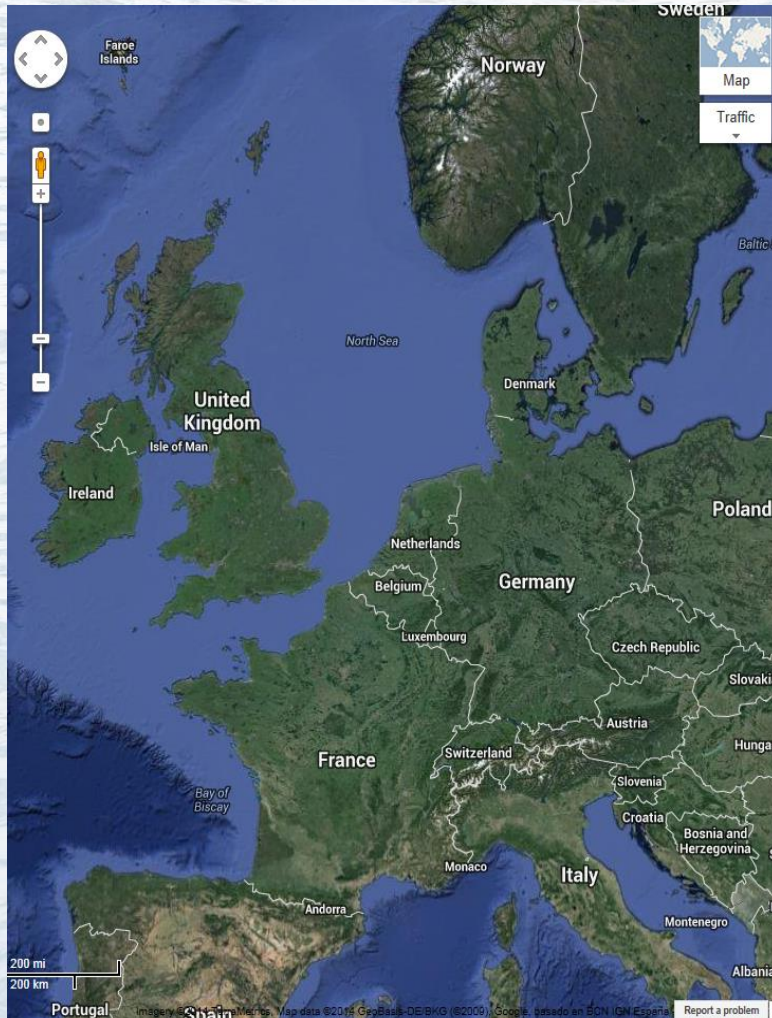

## European MaRVEN project

MaRVEN: Environmental Impacts of Noise, Vibrations and Electromagnetic Emissions from Marine Renewables

- examples of measurement instruments, sensors, results, applicable standards
- Potential for models to support or replace the use of measurement.
- Information required for specific measurement programmes to develop valid modelled impact assessments?
- Addressing the level of uncertainty around existing measurement and modeling options, or the interpretation of their results

# Export cable - beach

Known  
Known



Figure - Measured magnetic field of Northwind export cable (50 Hz)



# EMF at Belgian wind farm

Known  
Known

Figure - Electric field and Magnetic field  
measured at the Belgian wind farms  
- Interarray cables



# Crossover from Other Industries

Known  
Known

- Power generation companies
- Sub-sea cable companies and networks
- How relevant is this information?

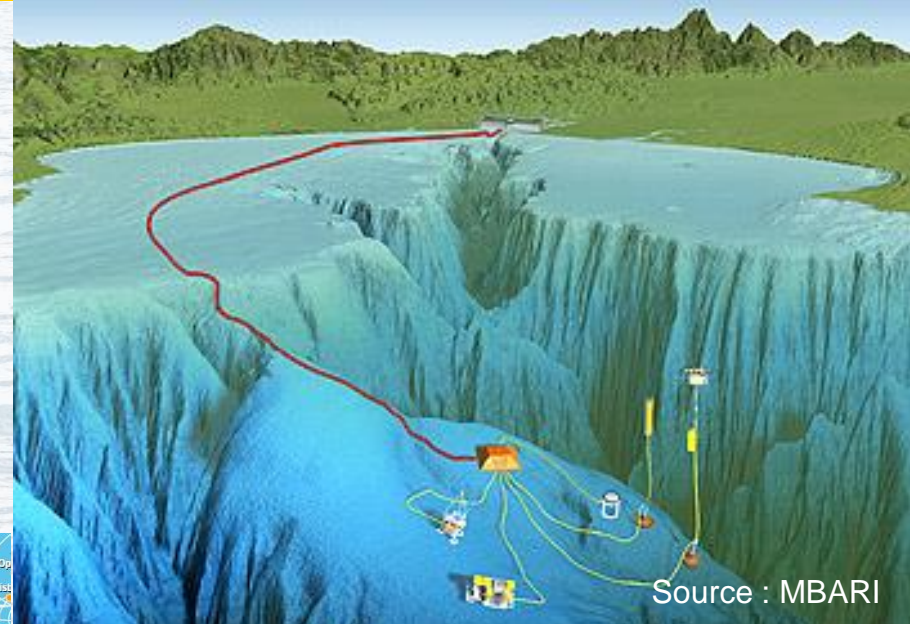

Source : MBARI

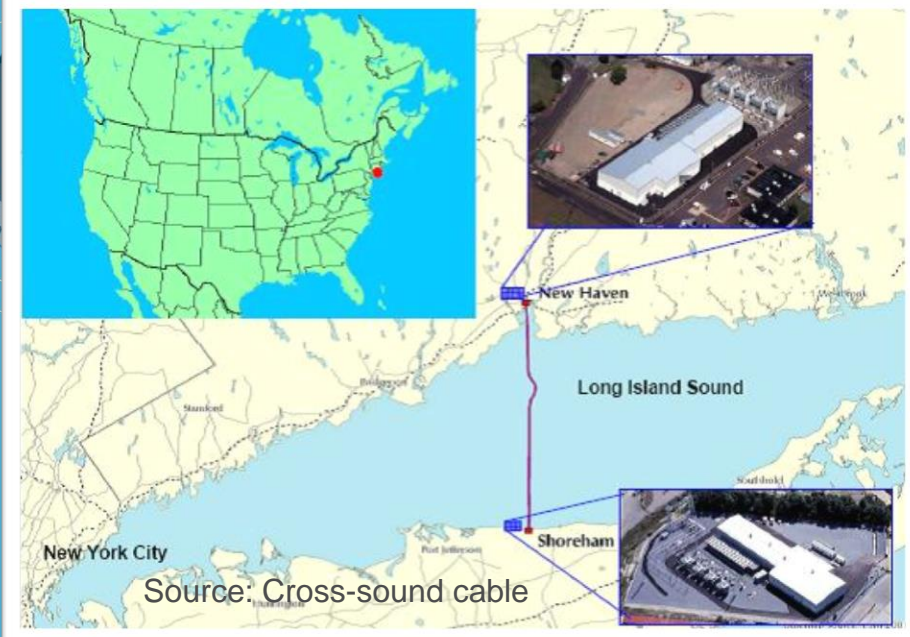

Source: Cross-sound cable

# What Should Be Measured to Enable Better Understanding of the Impacts?

Known  
Unknown

- *Dose response assessment:* Establish the response/effect on key marine species at their most sensitive stages of life to exposure to a range of EMFs (sources, intensities predicted from MREDs).
  - The importance of the effects lies in the data analysis that needs to apply analytical methods to assess emergent properties that would be associated with impact at the biologically relevant unit of the species population.
  - Effects need to be considered over the range (and not always avoidance or immediate)
- *Dose response assessment:* Field experiments (e.g. tracking studies) on the potential for impacts from multiple cables (cumulative) in relation to movement/migratory behavior of EMF receptor species.
  - Such studies should take relevant dose-response outputs and apply population based approaches (e.g. individually based modelling) to determine significance.
- *Exposure assessment:* Develop affordable techniques for measuring electromagnetic fields so as to validate EMF predictions within models.
  - If EMF is deemed of significance, based on above and further understand, then guidelines and standards for measurement methodology EMFs should be developed.

- Large uncertainty about the actual levels of EMF emitted from the MRED cables
- Cables vary according to different manufacturing process and different cable characteristics and deployments (e.g. burial v rock armouring). Creates uncertainty in emitted levels that cannot be modelled owing to lack of baseline data.
- If dose response studies highlight that exposure of marine organism to EMF is an issue then the understanding gained from field measurement programme will feed directly into considerations of how to mitigate the effects.
- Current measurement technology
  - B fields – available but restricted sensitivity
  - E fields - extremely limited?
- Technologies “in development” associated costs unknown

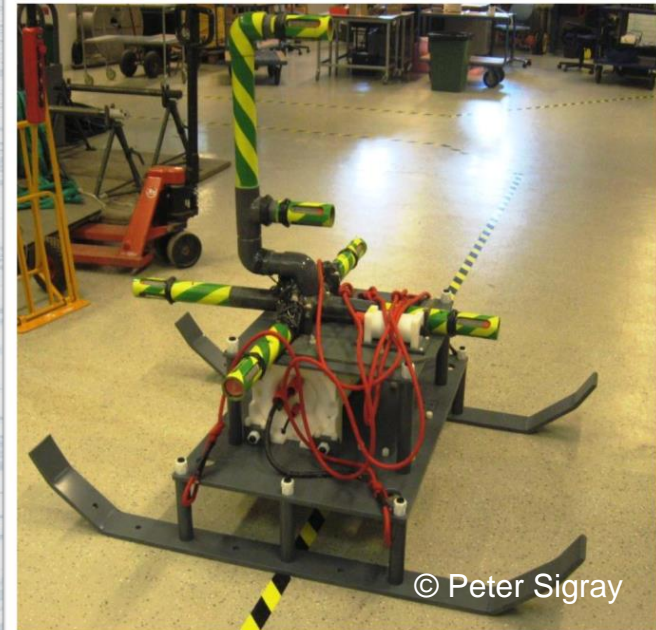



# What Questions Remain 1

Evaluate power system behavior w.r.t environmental conditions

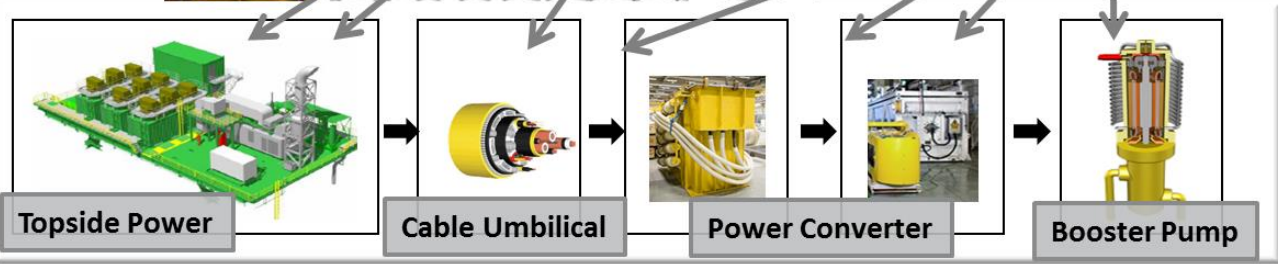
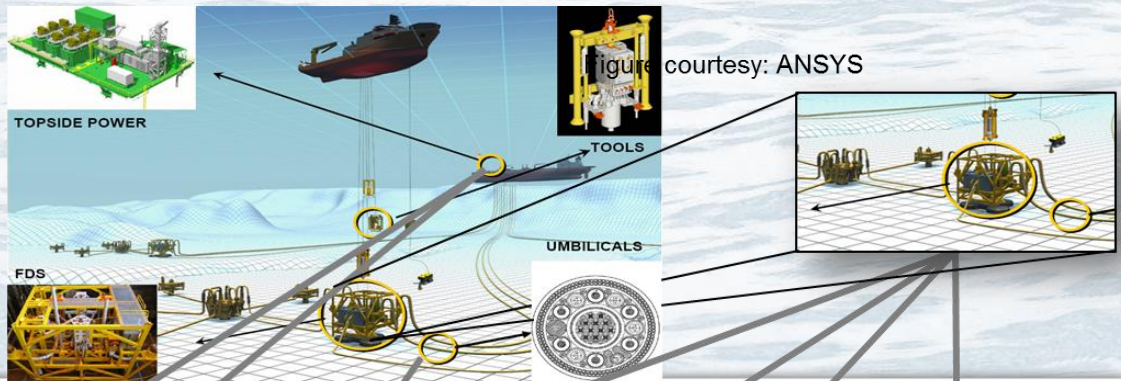
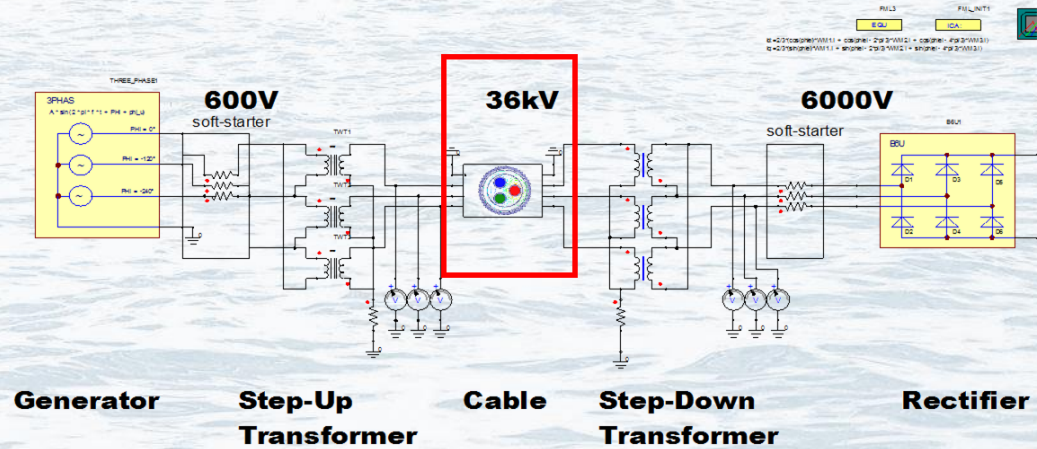

- Behavioural response – emergent properties

Along the cable trace

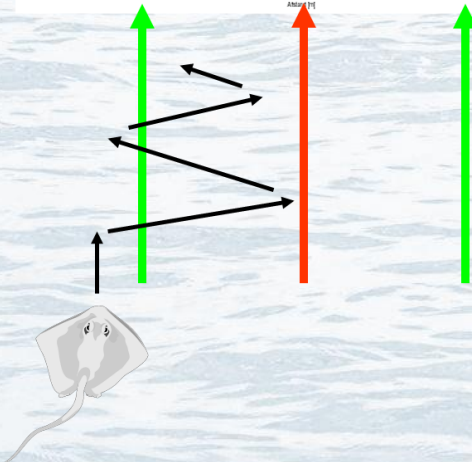
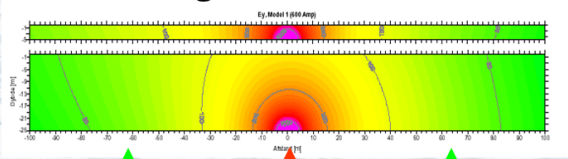

Within the cable array

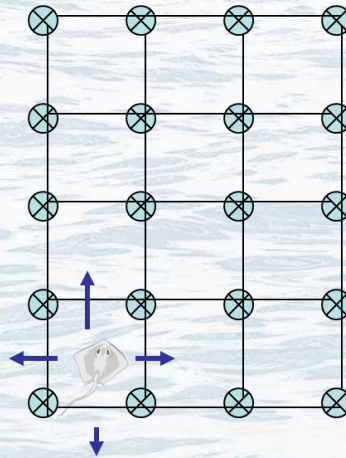

- Migratory life stage response

- Early life stage response

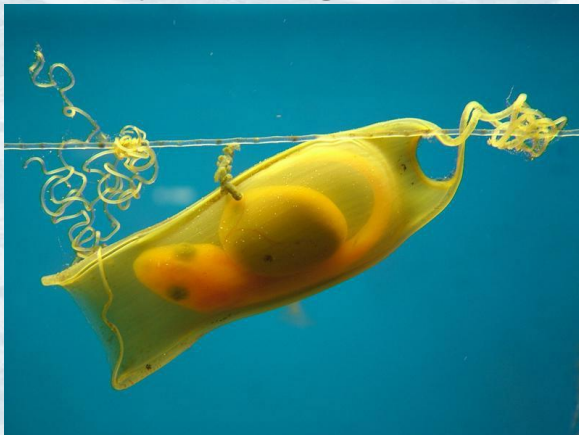

# If I was a Regulator...



- Currently a low level of confidence in the data for assessing whether there is an issue/concern
- Data use going forward
  - Accessing data
  - Sharing data
- The key remaining question(s):
  - Do we support the implementation of new technologies, such as MHK
  - Providing the context on which to make this decision
- General conclusions.