

Development of Active Acoustic Monitoring (AAM) for Marine Mammals around MHK Devices

Dr. Peter J. Stein
Scientific Solutions, Inc.

MHK Environmental Seminar

April 9, 2013



Active acoustics: Pros and cons

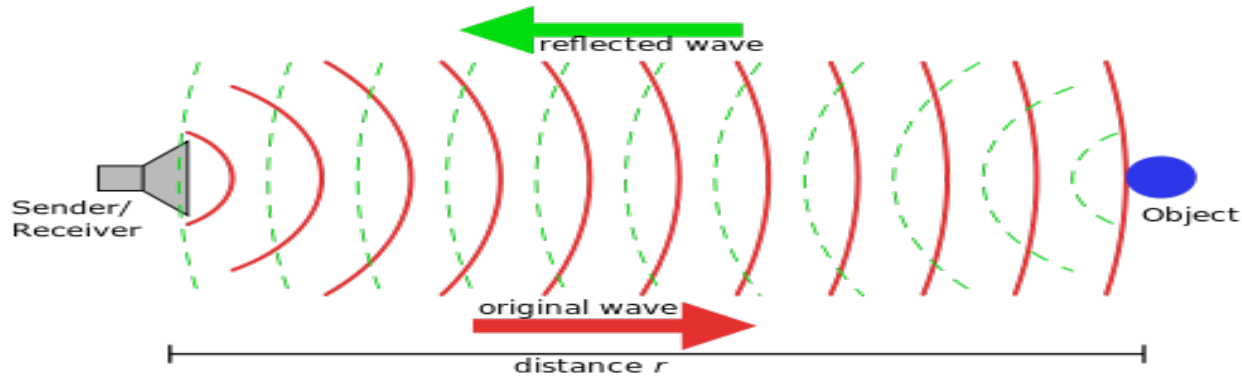

➤ Pros

- If you really want/need to detect, localize, and track an underwater object active acoustics (i.e. active sonar) is the most robust method

➤ Cons

- The effects of the active acoustic transmissions on marine life
- Systems often do not work that well for a variety of reasons
- Systems that work well are generally expensive and have limited coverage

Sonar Design Basics

- **Ability to accurately localize and image is related to size (aperture) as a function of wavelength (or inverse frequency)**
- **Operating at higher frequencies is better because the size of the sonar is small relative to its resolution**
- **Operating at higher frequencies is also better because the target echo strength is generally higher**
- **In this case, operating at higher frequencies is also better if we can get out of the hearing range of marine mammals**
- **But absorption of sound in sea water increases dramatically with frequency**
- **So operating at lower frequencies gives you longer range**

One-way propagation loss

Propagation loss for different frequencies Spherical Spreading ($20 \log R + aR$)

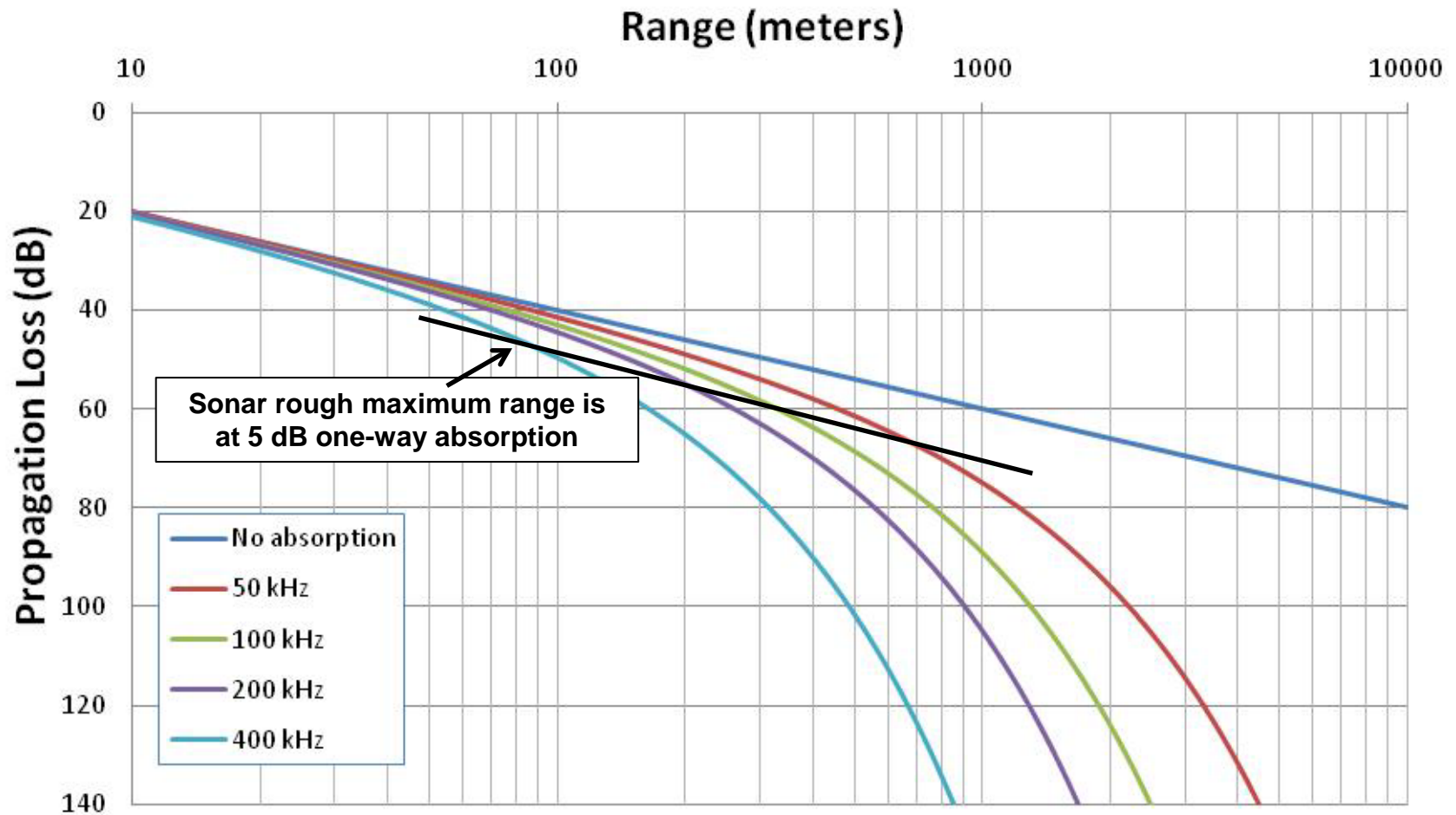

Common systems for bio-acoustic research

Different categories roughly depending on frequency

Imaging

Generally >400 kHz

Classification possible

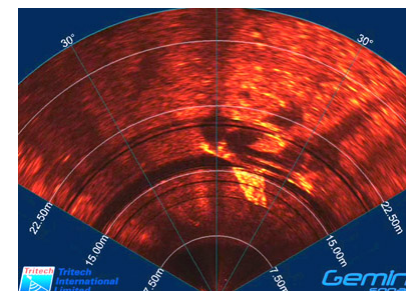
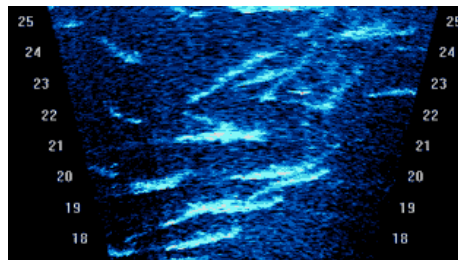

Fish-finding

Generally 50-200 kHz

Location and estimation of bio-mass possible

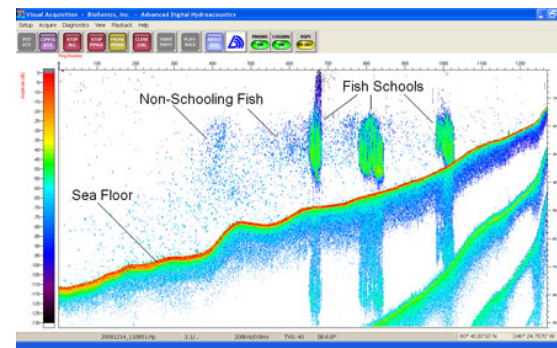

Longer range detection, localization, and tracking (30-100 kHz)

Robust classification not developed yet

Track-before-alert

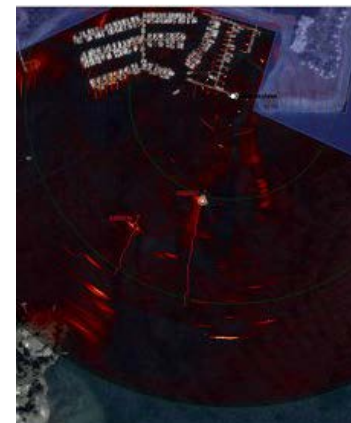
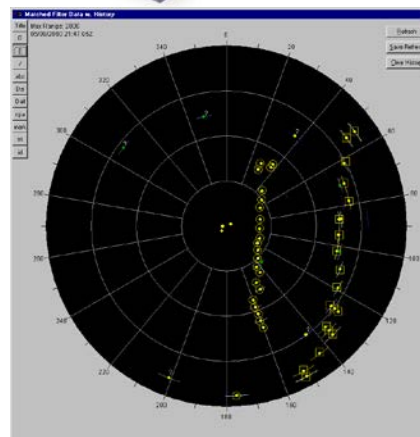

Audiograms

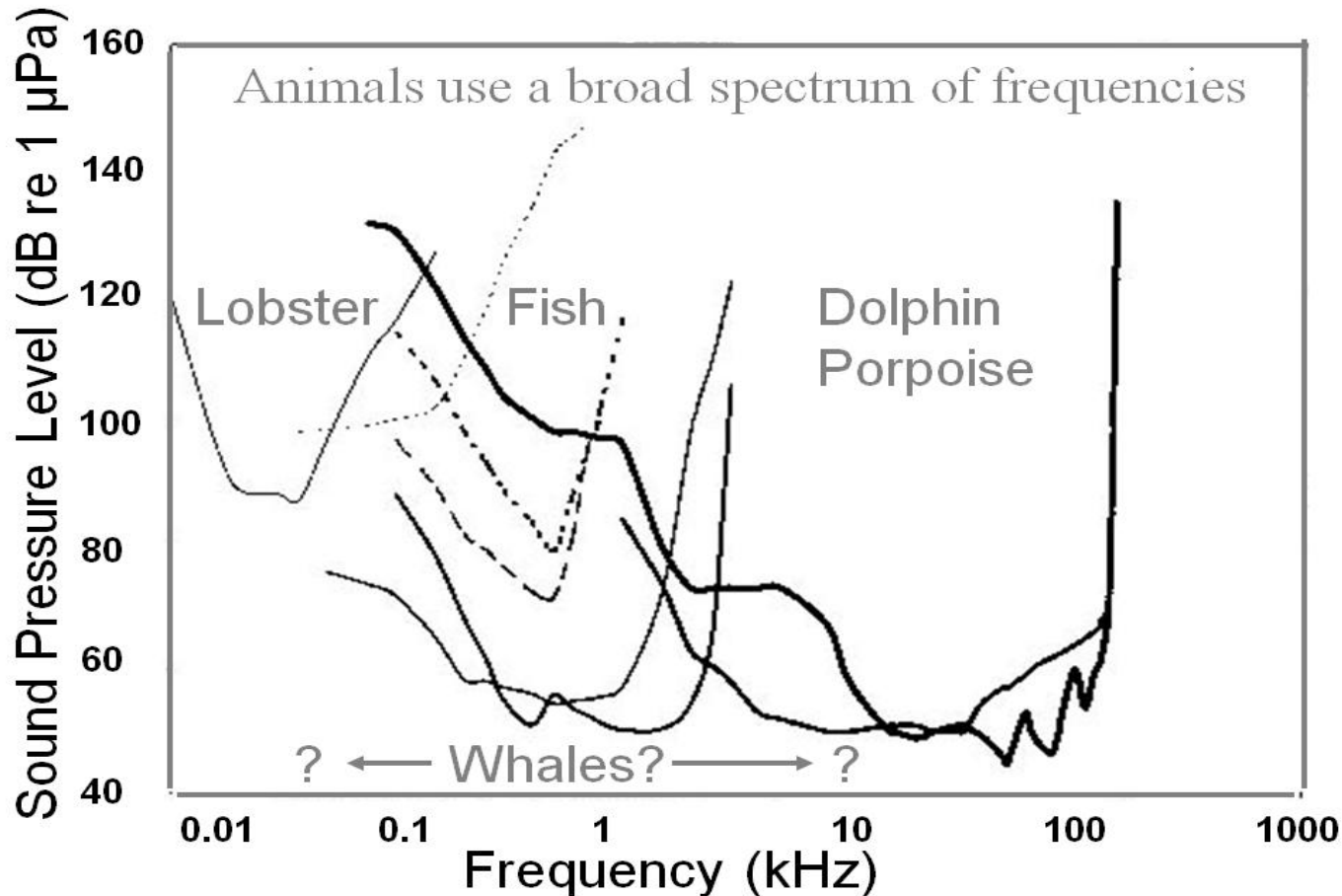

- Operating at frequencies where small odontocetes will not hear the sonar severely limits detection/tracking ranges
- Operating at frequencies where whales will not hear the sonar and detection/tracking ranges are useful is possible, but avoidance testing is required

The problem at hand

Evaluating the risks of MHK Installations

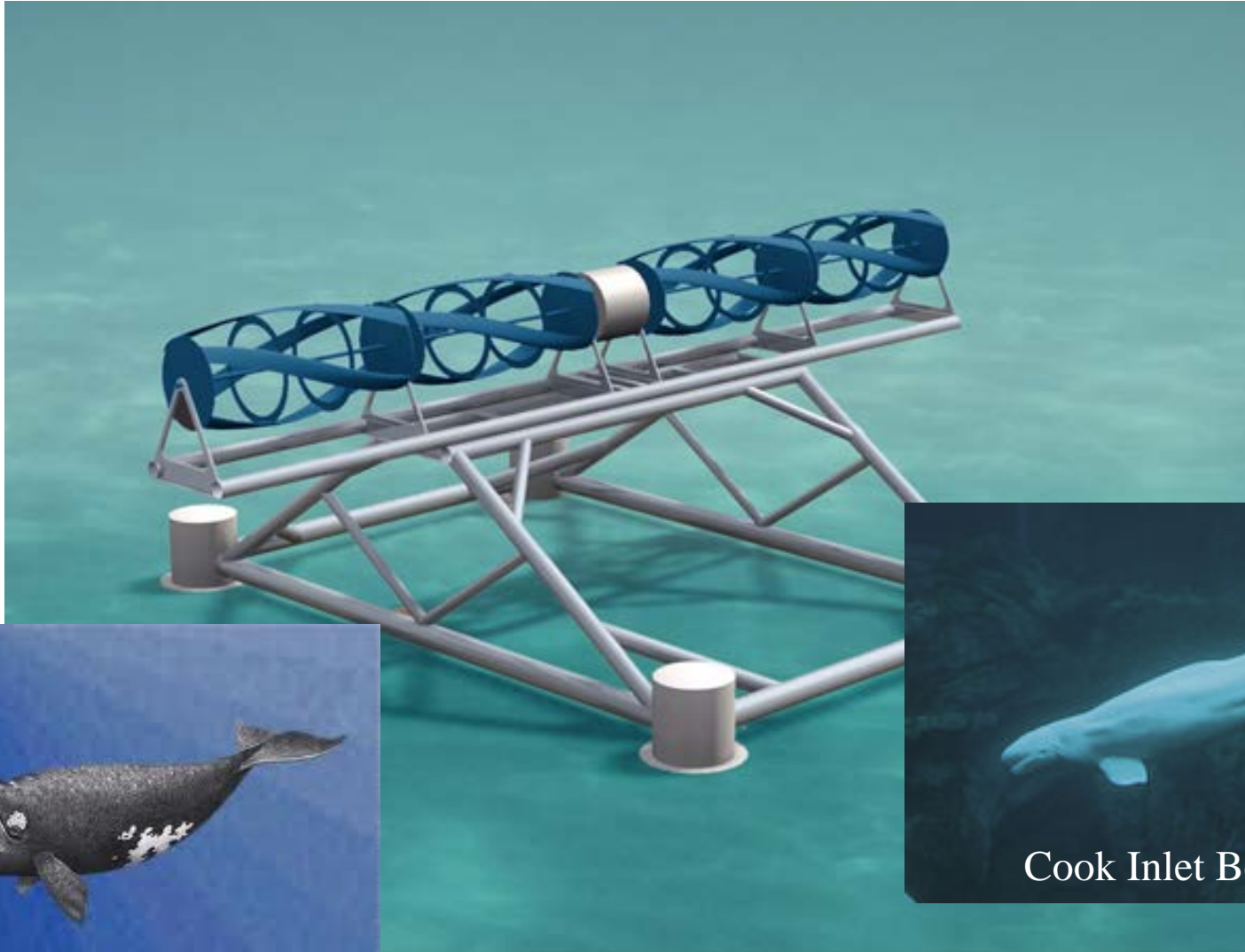

North Atlantic right whale



Cook Inlet Beluga

Swimmer detection systems as a basis for AAM

- **Effective AAM for offshore renewable energy applications has pretty much the same requirements as swimmer detection sonar**
 - **Automatic detection, tracking, localization, and classification of low target strength objects in a shallow water harbor environment**
- **Swimmer detection sonar systems are fairly well developed, however most are very expensive and classification is still an issue**
- **SSI has been working since 2002 to develop a cost effective swimmer detection sonar system based on networking simple inexpensive sonar “nodes”**
- **The SSI/ORPC AAM program is based on leveraging the on-going SDSN development**

Swimmer Detection Sonar Network (SDSN)



First generation node (right) and second generation node left 45-75 kHz

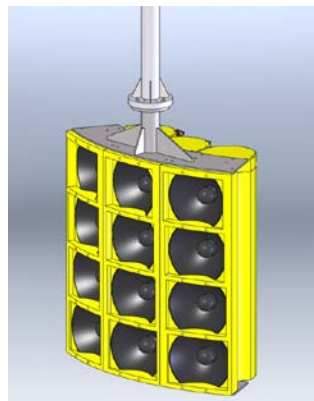

Three node "cluster" 45-75 kHz



Second Generation Node 90-120 kHz (AAM System)

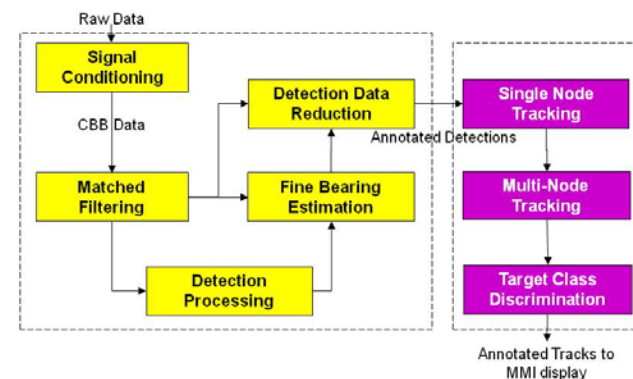
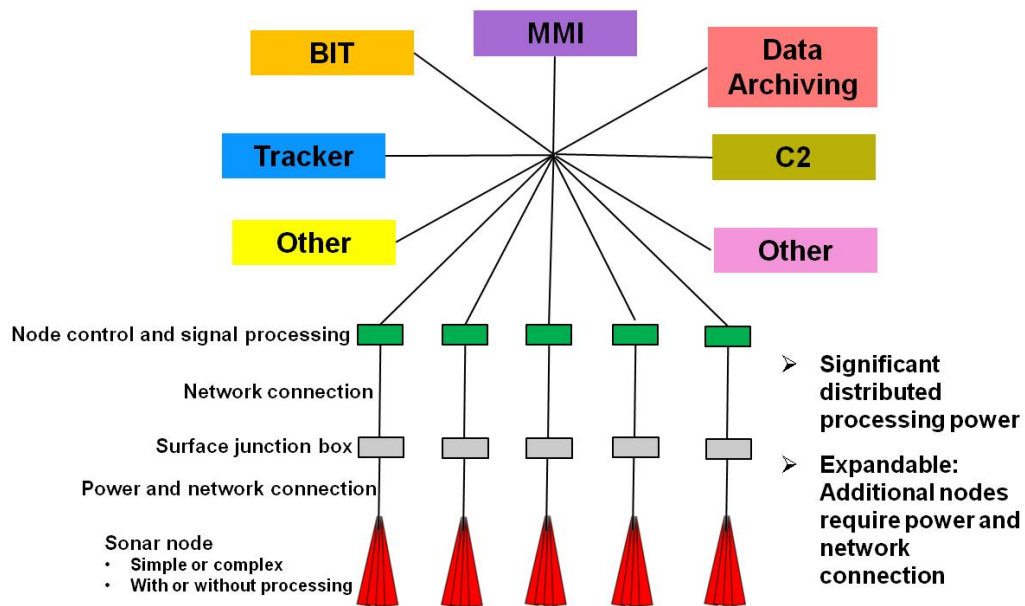

SDSN trial results

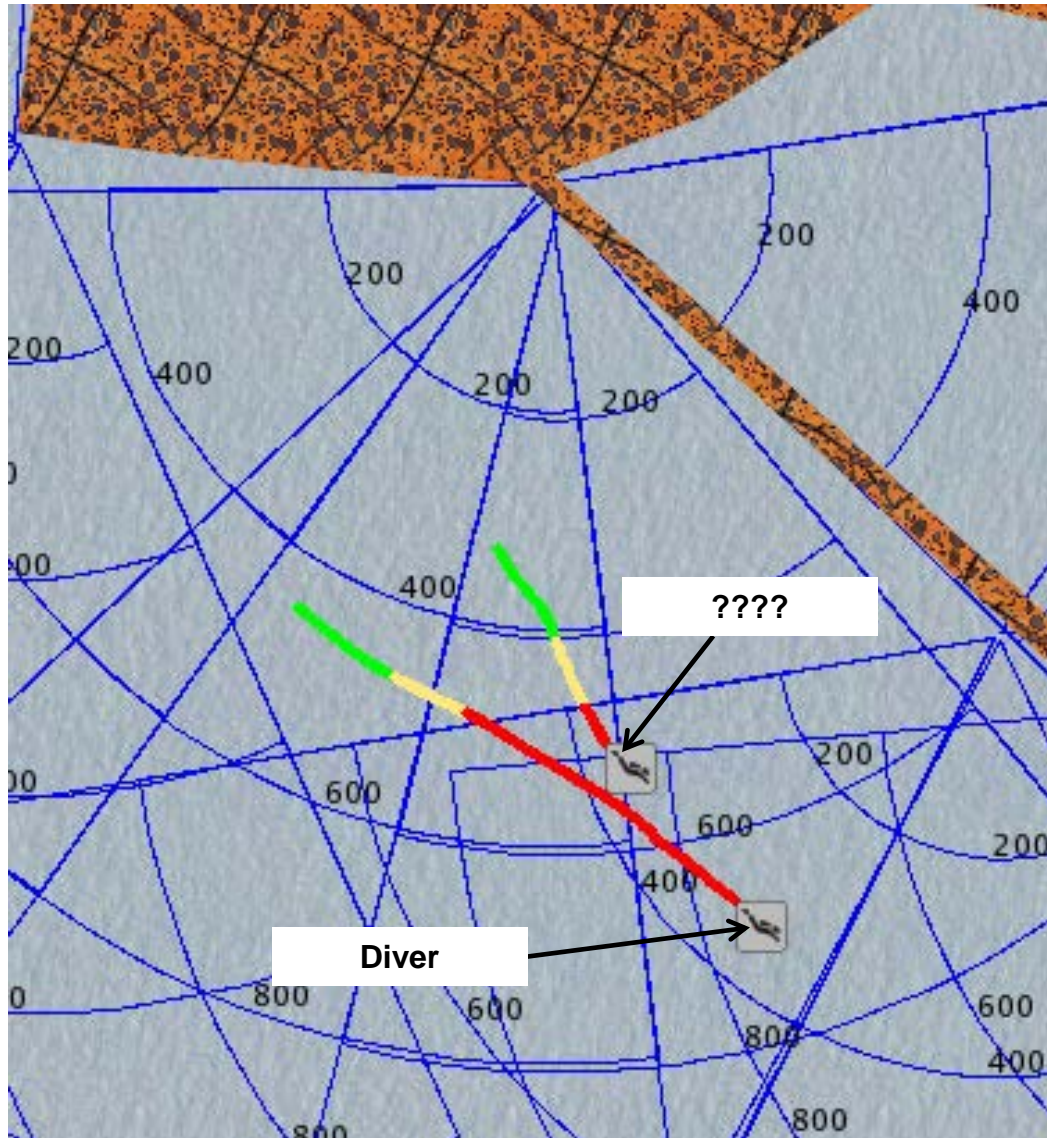

Test installation using G1 nodes on Beta Unit

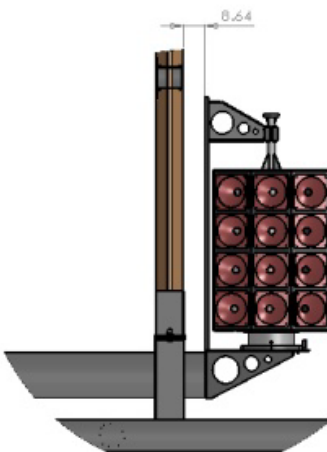
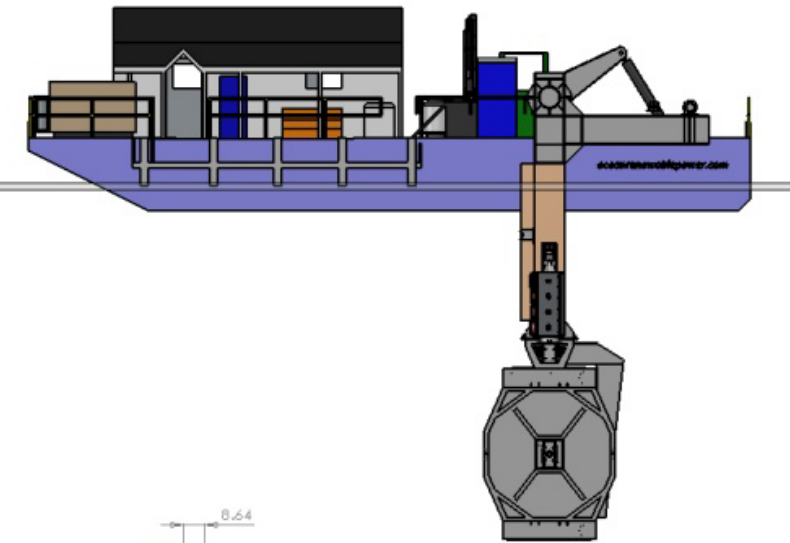
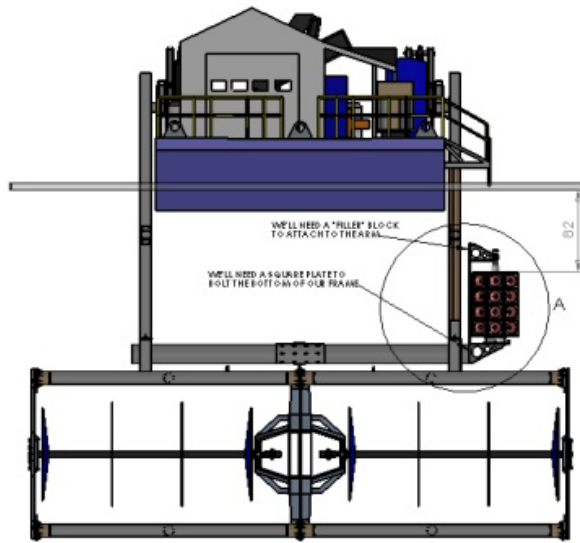

DETAIL A
SCALE 1 : 20

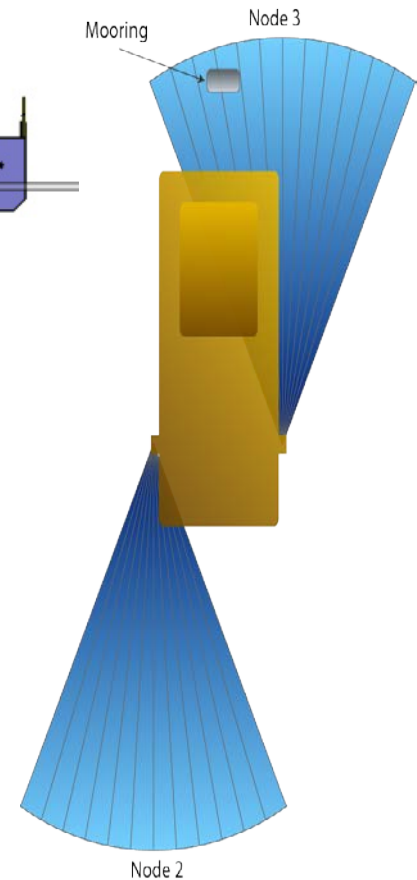

Will SDSN work in high currents??

Node installation



Small target tracking results

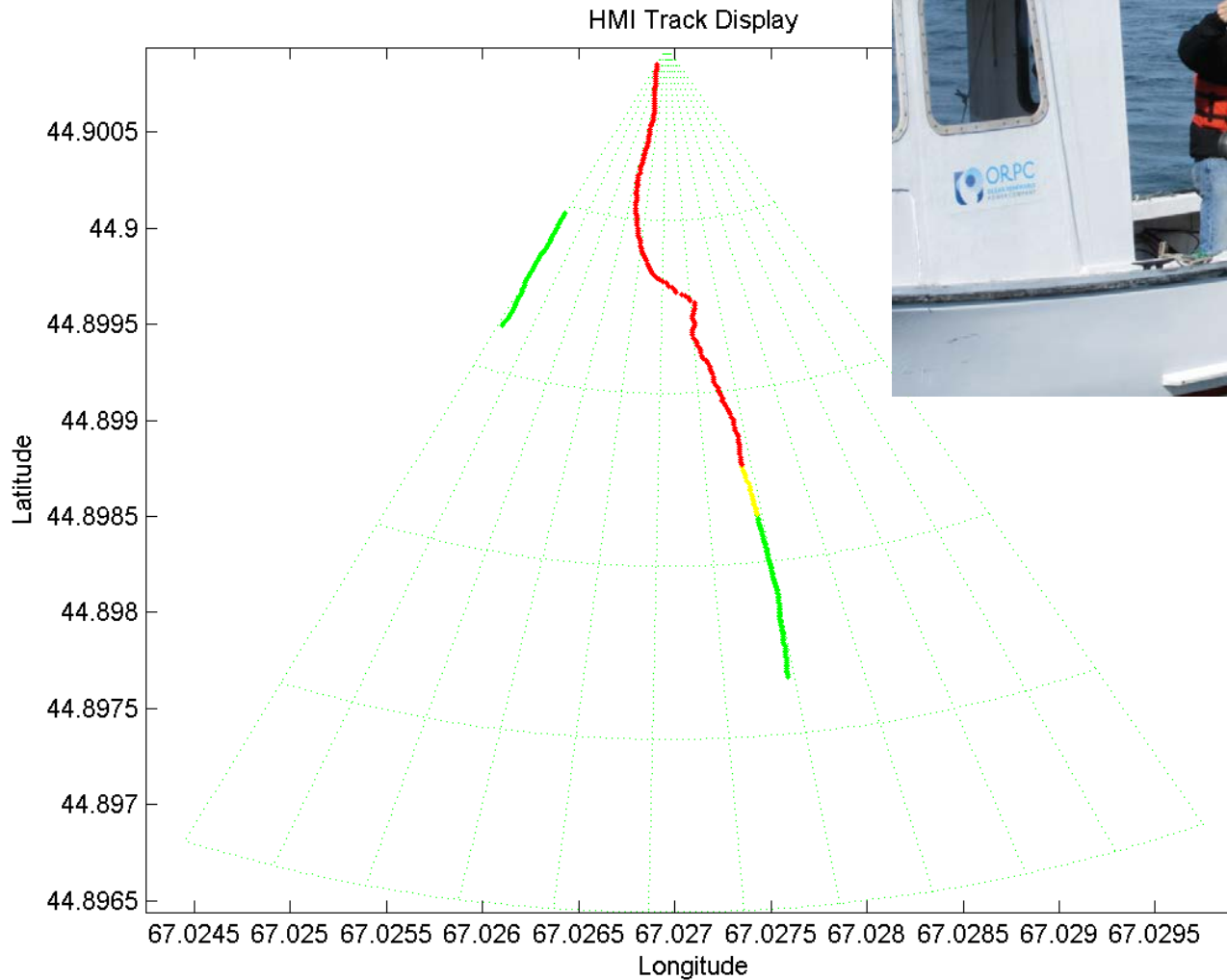

AAM TidGen™ installation (May 2013)

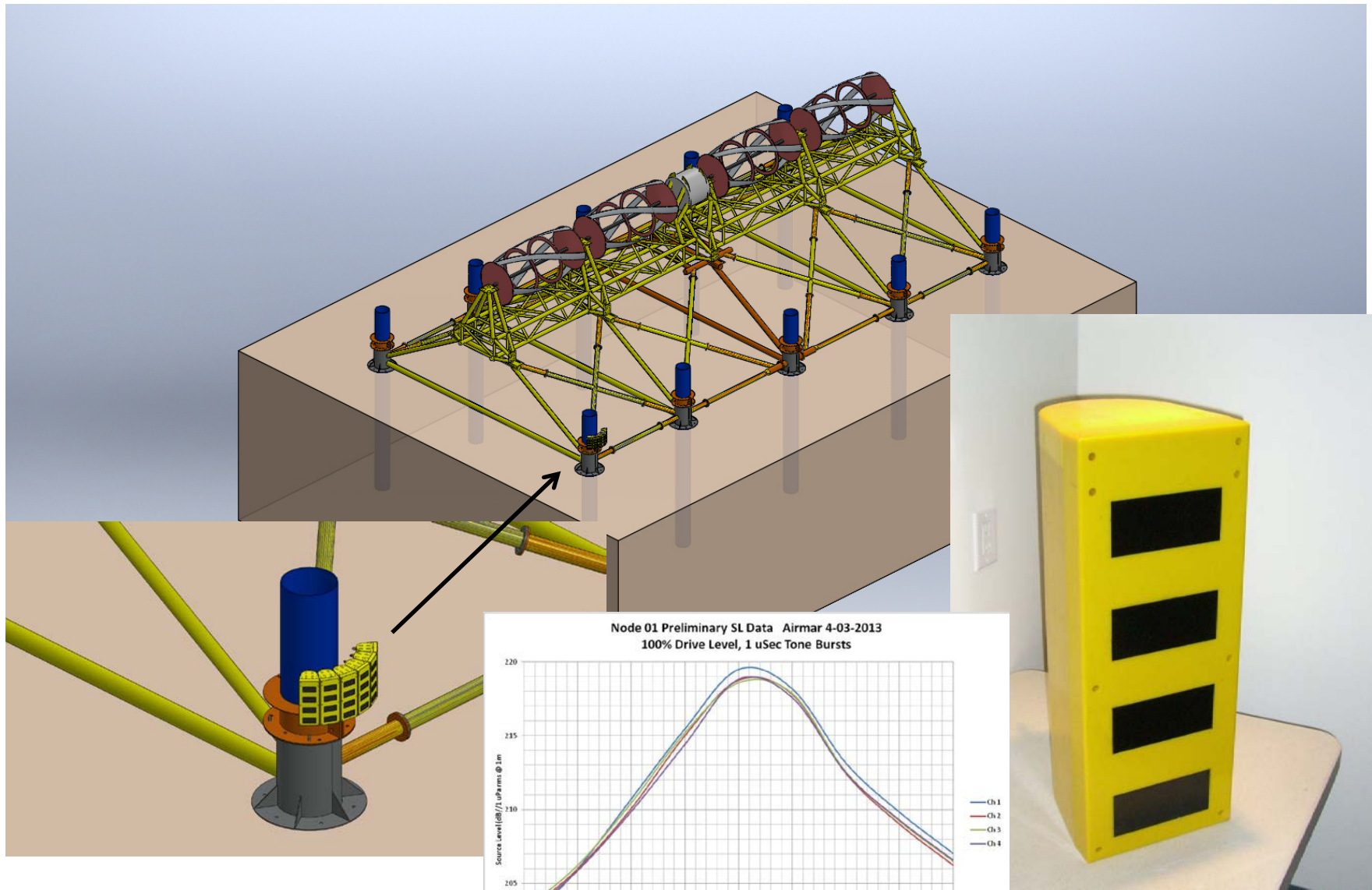

Integrated near-field and far-field coverage

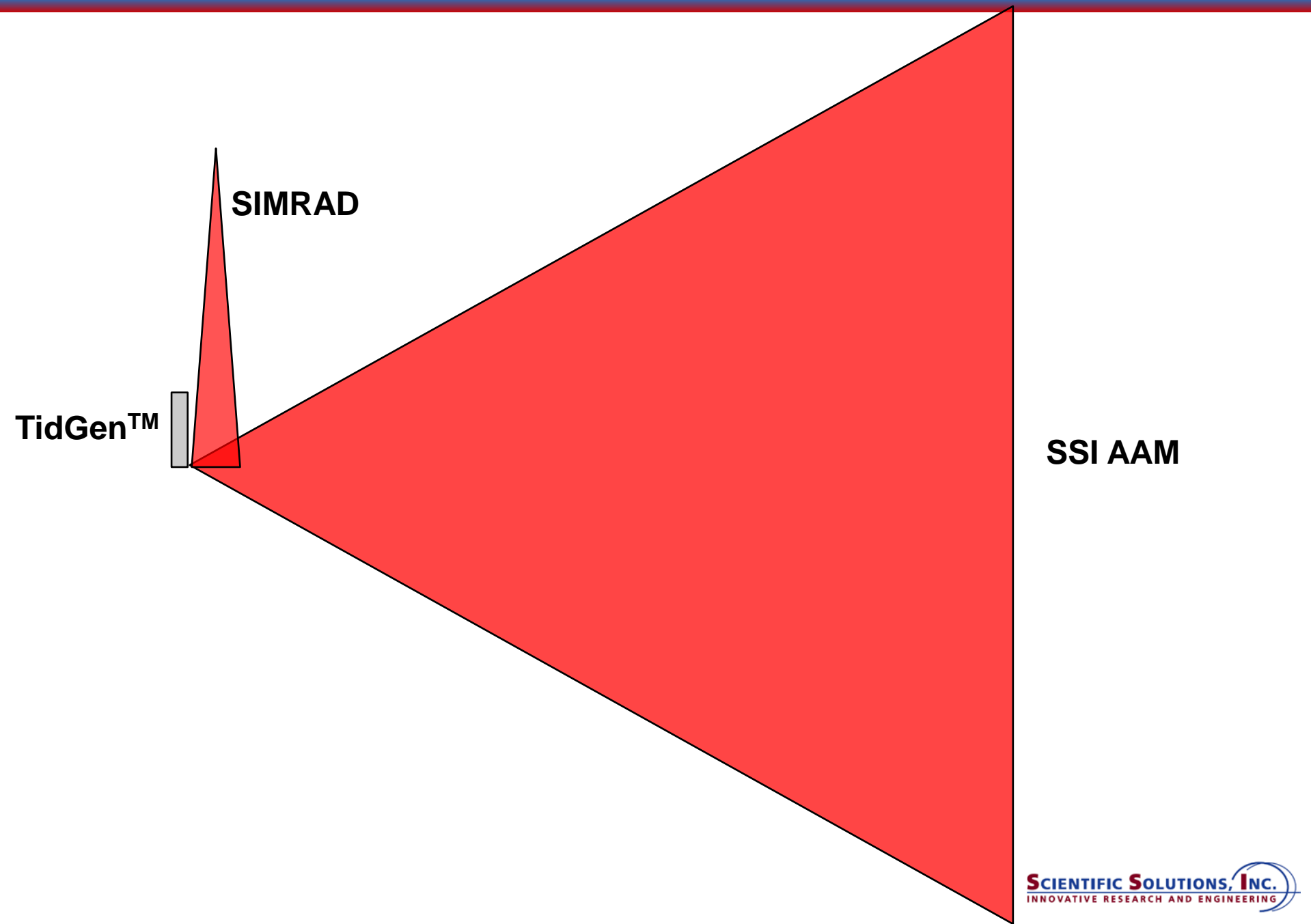

Permitting for AAM

- **SSI has obtained a Letter of Concurrence (LOC) from NOAA/NMS**
- **Limitations/requirements are:**
 - **AAM operation cannot exceed TBD hours per month (asking for 160)**
 - **We must have 2 marine mammal observers**
 - **Must shut down if a marine mammal approaches within 100 m**
 - **Must shut down if an endangered species comes within 1 mile (basically is sighted)**
- **24/7 permitting would be difficult due to harbor porpoises that hear up to 200 kHz**

What the Cobscook Bay installation will do

- **Advance the 90-120 kHz AAM (SDSN) development**
- **Demonstrate integration of AAM with TidGen™ including mounting and data transfer to shore**
- **Demonstrate the ability to track objects approaching the turbine**
 - **Test targets**
 - **Schools of fish**
 - **Floating debris**
- **Integrated data set (SIMRAD/AAM) should allow us to determine the approach path of objects to the turbine, what approached the turbine, and the behavioral response.**

What the Cobscook Bay installation will not do

- **Advance AAM signal processing to track marine mammals**
- **Determine the avoidance response of marine mammals to AAM or the turbine**
 - **We might get some seals, but we will not be able to tell if any reaction was due to the turbine or the AAM system**
 - **But endangered species like right whales and belugas are the concern**

**Experiments with these specific goals
must be conducted**

Example - MAST 2004

- Integrated visual and active tracking of grey whales off the coast of California
- SSI obtained, and successfully defended in court, a scientific research permit to conduct the tests
- Goal was to develop an integrated system, including AAM, and determine if there was an avoidance reaction to AAM



MAST Results

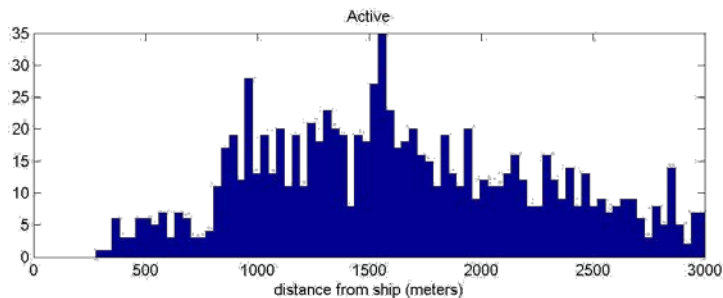
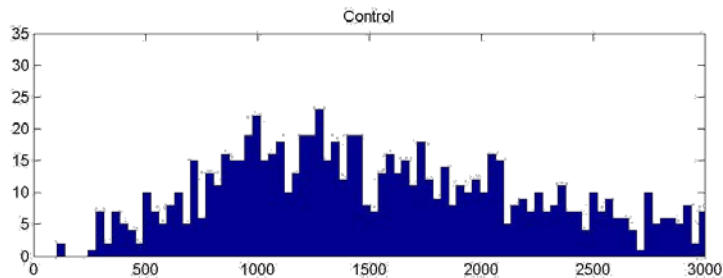
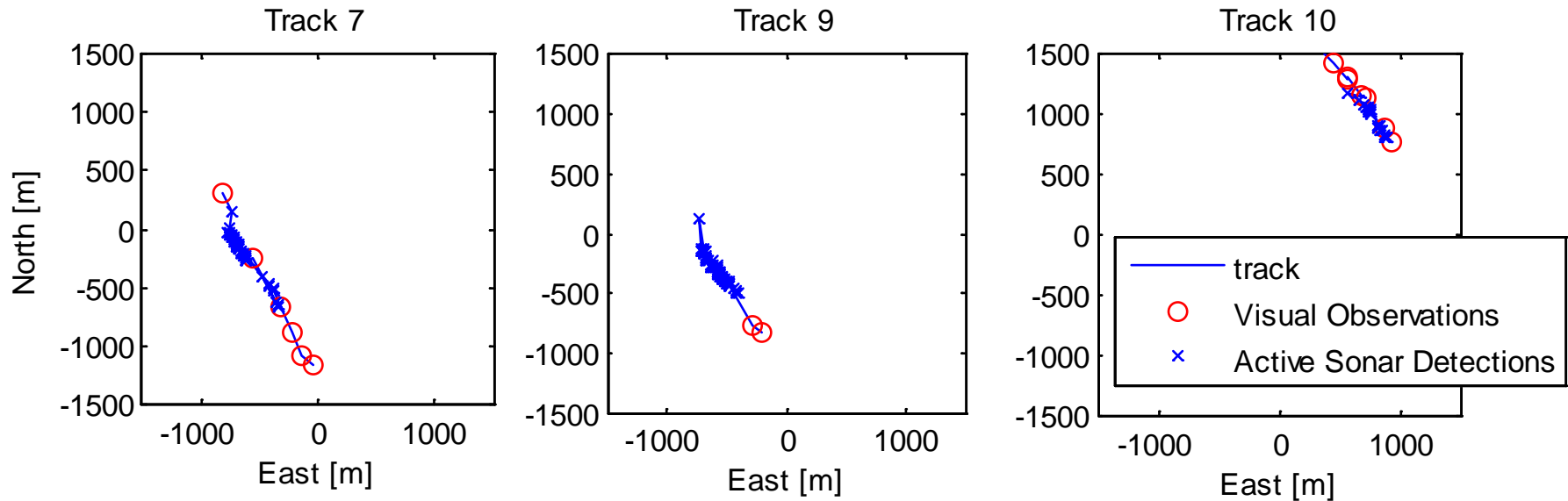

Grey whales hear the sonar and do have an avoidance reaction – 20-26 kHz

Frankel, A.S. 2005. Gray whales hear and respond to signals 21 kHz and higher. Page 97 in Abstracts, Sixteenth Biennial Conference on the Biology of Marine Mammals, San Diego, California.

Required Further AAM Experiments

- **Goal is to develop AAM for 500 m range (90-120 kHz), determine any avoidance reaction to AAM, and determine avoidance reaction to turbines**
- **MAST-like integrated monitoring experiments**
 - **Visual**
 - **Active acoustics (use Cobscook Bay system)**
 - **Passive acoustics**
 - **Tagging**
- **Region and time with high concentration of pertinent species**
 - **Right whales**
 - **Belugas**
 - **Other**
- **With and without turbines present**
- **U.S. and Canada jointly funded program?**
- **Extensive planning required, including getting a scientific research permit that will need an EA**

Potential Sites

**Nova Scotia
Right whales**



**Massachusetts /
Cape Cod Bay
Right whales**

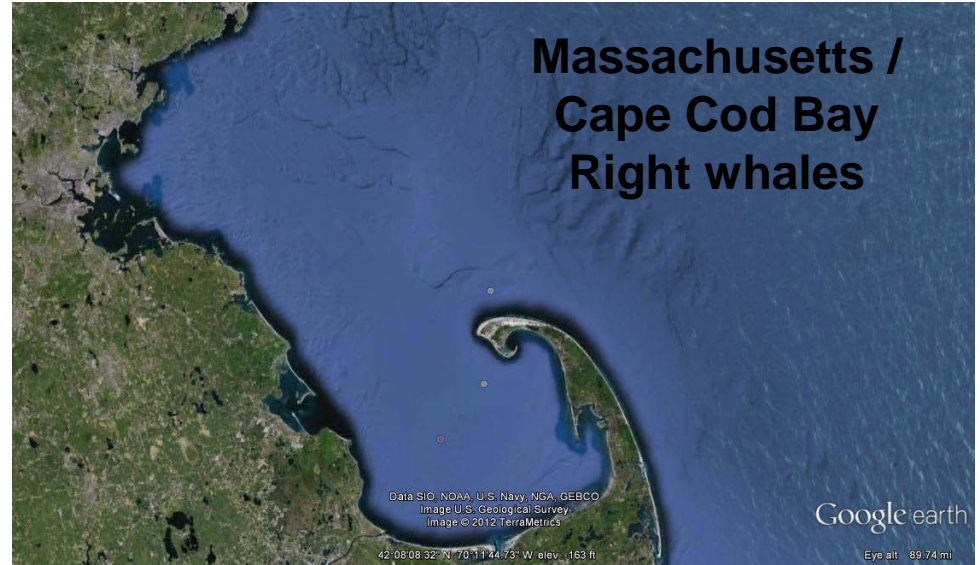

**Cook Inlet
Belugas / Other**



**California (San
Luis Obispo)
Grey whales**



Where should we head with AAM??

- **24/7 operation of AAM in the 90-120 kHz range will be difficult to permit in many cases**
- **Best applications are temporary:**
 - **Monitoring to determine effects**
 - **Determine animal behavior around MHK devices**
 - **Mitigation for high-danger temporary anthropogenic activities**
 - **Pile driving**
 - **Oil and gas exploration**
 - **Explosive removal of offshore structures**
- **Best path forward for AAM development**
 - **Series of experiments to develop AAM and prove it is not harmful to the most sensitive endangered species**
 - **Use AAM to determine avoidance reaction to MHK devices (species dependent)**
 - **Commercialize AAM as a mitigation tool for high-danger activities**